

# 圣戈班速造 产品手册 墙面系列

**INSPACE  
WALL SYSTEMS  
INTRODUCTION**

# COMPANY PROFILE

## 企业简介

### 世界 500 强

由世界五百强，全球建材行业龙头企业圣戈班以及中国本土公装领域独角兽企业领筑智造合资建立的创新科技企业。

### 信息化

行业领先全生命周期信息化管理系统，设计方案垂直打通生产和施工环节，设计时间下降 70%，损耗降低 20%

### 装配式

装配式装修技术领导者，产业赋能者。整体空间一体化解决方案，设计、生产、施工、项目全流程支持。

### 产业互联

通过建立开放、协作的方式，和更多合作伙伴一起建立装配式技术生态圈，为项目方提供一站式服务。



圣戈班速造建筑科技(成都)有限公司 (INSPACE) 是由世界五百强，全球建材行业龙头企业圣戈班集团以及中国本土公装领域独角兽企业领筑智造合资建立的创新科技企业，致力于利用装配式、信息化技术提升建筑与装饰行业的整体效率。

公司目前定位于开发、制造和销售。为各类公共建筑项目及装饰公司提供装配式装修整体方案，制造符合使用需求的模块化空间产品。

圣戈班速造希望通过建立开放、协作的方式，和更多合作伙伴一起建立装

配式技术”生态圈。

INSPACE is a joint venture between Saint-Gobain, one of the world's top 500 companies in the building materials industry, and Indeco, a local Chinese unicorn company in the public decoration sector, which is dedicated to using assembly and information technology to improve the overall efficiency of the construction and decoration industry.

INSPACE is currently focused

on developing, manufacturing and selling modular prefabricated assembly and decoration solutions for all types of public buildings and decoration companies.

INSPACE hopes to establish an open, collaborative approach to building the "assembly technology" ecosystem with more partners.

# COMPANY PROFILE

COL 国际工程

## 企业愿景



创新

合作

坚持

超越

专业



# C 目录 CONTENTS

## 公司介绍 /Company Introduction 01/02

## 墙面饰材介绍 /Introduction to the wall system 05/10

美耐系列 墙面系统.....	05/06
AWC 系列 墙面系统.....	05/06
特耐系列 墙面系统 (CC 板).....	07/08
SPC+ 系列 墙面系统 (SPC+ LT 板).....	09/10
WPC 系列 墙面系统 (WPC Stone).....	11/12

## 隔墙系统介绍 /Introduction to the partition wall system 13/17

可复用装配式隔墙.....	13/14
特耐系列 一体化隔墙 / 分拆式隔墙.....	15/17

## ENF 级基材 /ENF grade substrates 18

## 装配式围挡 /Prefabricated enclosure 19/20

## 拼接方式与配套线条 /Stitching and matching lines 21/24

SBS 系统 拼接方式与配套线条.....	21/22
BUS 系统 拼接方式与配套线条.....	23/24

## 适用场景与案例 /Applicable scenarios and cases 25/44

连锁酒店 推荐 美耐系列.....	25/28
连锁餐饮 推荐 特耐系列.....	29/32
办公空间 推荐 SPC+ 系列.....	33/36
城市更新 推荐 WPC 系列.....	37/40
医疗康养 推荐 AWC 系列.....	41/44

## 颜色说明与售后 /Color description and after-sales 45/46



## 墙面产品目录

我们将常用场景所需的墙面功能需求进行整理，把常见的尺寸和固定搭配确定下来。经过圣戈班亚太研发中心不断研发形成了多种系列墙面产品。同时我们精心设计了不一样的外观风格的配套产品供客户选择。

### A 级防火 墙面系统

美耐系列 墙面系统

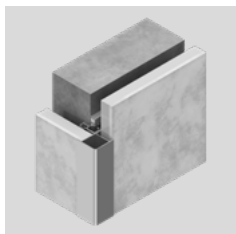

AWC 系列 墙面系统

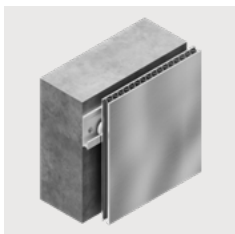

特耐系列 墙面系统



### B 级防火 墙面系统

SPC+ 系列 墙面系统

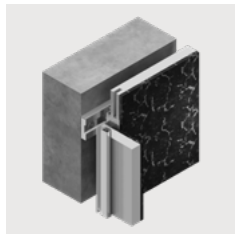

WPC 系列 墙面系统

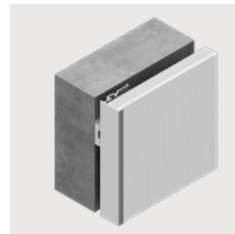

### 装配式侧装隔墙

可复用装配式普通隔墙

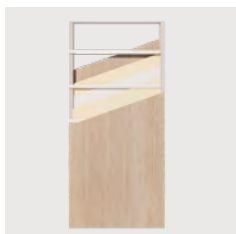

可复用装配式高隔音隔墙



### ENF 级基材

哈比特® 系列 基材



AK 系列 基材



### 装配式一体化隔墙

特耐系列 一体化隔墙



特耐系列 分拆式隔墙



### 装配式围挡

可复用围挡



活动围挡





## 美耐系列 墙面系统

美耐系列 墙面系统 选用优质的原材料经过圣戈班亚太研发中心优化精准配料，经制浆成型，由 9000 吨专用压机压制，得到硅酸钙板。再以 100% 无石棉的硅酸钙板为基材，在技术上使用三聚氰胺纸通过高温高压进行表面处理，使其具有高效的防火性，抗老化性、耐水性，抗菌性等特性，同时保持亮丽的外观，给人以清洁感。

### 板材优势 /Plate advantages



#### 环保无醛

甲醛释放量小于 0.1mg/L, 不含放射性元素  
优于欧标 EO 级 0.5mg/L, 即装即住, 环保可靠



#### 密度

密度为  $\geq 0.85\text{g}/\text{m}^3$



#### 高强

防刮耐磨、抗折、抗弯、抗冲击、抗下陷；吸水膨胀率  $\leq 0.5\%$



#### A2 级防火

阻燃材质，离火自熄  
防火阻燃、保温隔热、不脆化，杜绝安全隐患



#### 易洁

耐污染  $\geq 4$  级，易清洁



#### 耐蚀

防霉抗菌，涂层可有效防止酸碱、药剂类液体侵蚀



### 规格说明 /Specifications

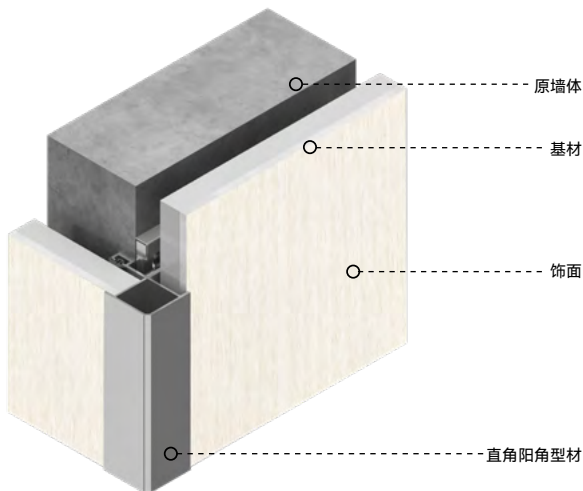

宽 (w) X 高 (h) mm:	厚 (t) mm:
600mm*2440mm / 600mm*3000mm	(6mm)
600mm*2440mm / 600mm*3000mm	(8mm)
600mm*2440mm / 600mm*3000mm	(9mm)
600mm*2440mm / 600mm*3000mm	(10mm)
1220mm*2440mm / 1220mm*3000mm	(5mm)
1220mm*2440mm / 1220mm*3000mm	(6mm)
1220mm*2440mm / 1220mm*3000mm	(8mm)
1220mm*2440mm / 1220mm*3000mm	(9mm)
1220mm*2440mm / 1220mm*3000mm	(10mm)



## AWC 系列 墙面系统

AWC 系列 墙面系统 选用优质的 A3003 铝合金原材料经过圣戈班亚太研发中心优化精准配比的基材上复合其他材料，经特种加工成型。这是一种代表建筑行业未来趋势的新型装饰材料，具有 0 排放的环保原料，更加稳定的板材结构。其次圣戈班的高精度的加工生产线，让板材的色彩能够持久抗衰。同时可无痕阳角折弯。

### 板材优势 /Plate advantages



#### 环保无醛

0 排放，不含放射性元素，无苯，无醛  
甲醛释放量 0mg/L



#### 轻质

铝材质为主，重量轻，平整度高



#### 高强

抗折、抗弯、抗冲击、抗下陷  
超稳定板材结构



#### A 级防火

阻燃、抗变形材质，离火自熄  
适用于有防火限制场所的内装饰



#### 易洁

耐污染，易清洁



#### 耐蚀

采用 3003 优质铝合金原材料，防腐蚀，防锈铝

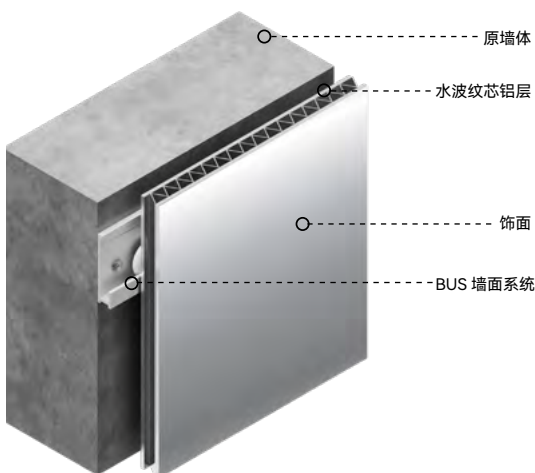

### 规格说明 /Specifications

宽 (w) X 高 (h) mm:	厚 (t) mm:
600mm*2440mm / 600mm*3000mm	(8mm)
1220mm*2440mm / 1220mm*3000mm	(8mm)

## 特耐系列 墙面系统

特耐系列 墙面系统 学名为热固性树脂浸渍纸高压层积板，英文缩写为 HPL (Decorative High-pressure Laminate) 是表面装饰用耐火建材。是以 A 级 AK 系列板材为基材，全程作全程作业方式为干法作业，免去传统湿法作业批灰抹水泥的缺陷，安装过程无水无尘少污染，作业环境干净卫生，现场采用龙骨干挂安装方式，有效较少材料浪费现象，大大提高安装效率，降低综合成本。

### 板材优势 /Plate advantages



#### 环保无醛

ENF 级环保，无甲醛，不含放射性元素  
产烟毒性安全等级 AQ1 级



#### 超强握钉力

拥有良好的握钉力



#### 高强

抗冲击、耐磨、耐刮擦



#### A 级防火

A 级不燃基材，耐火极限 3 小时  
适用于防火限制场所的内装饰



#### 轻质

重量轻，平整度高



#### 易加工

柔性材料，二次加工简单便捷

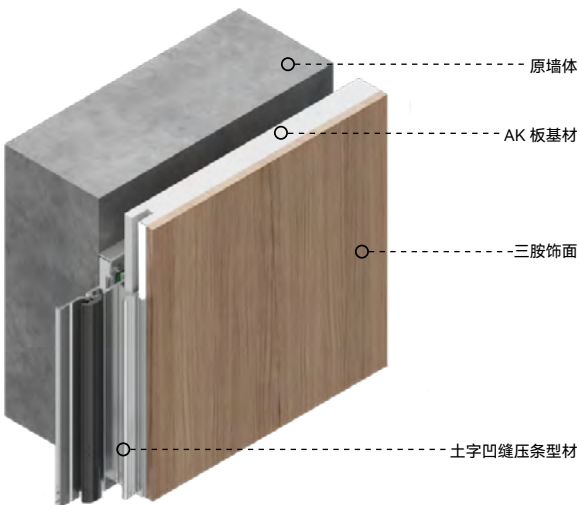

### 规格说明 /Specifications

宽 (w) X 高 (h) mm:	厚 (t) mm:
600mm*2700mm / 600mm*3000mm	(10mm)
900mm*2700mm / 900mm*3000mm	(10mm)
1200mm*2400	(9mm)





## 特耐系列 墙面系统®CC 板

特耐系列 墙面系统®CC 板，是特耐系列中的一种特殊板材。由多层装饰纸高温高压而成，芯材与表层采用相同的装饰纸，呈现和谐统一的效果，边缘无需特别处理，室内装饰及定制家具搭配质感十足的肌理，或光滑或粗糙，营造简约而优雅的现代感空间。适用于卫生间分割、卫生间分割挡板、家具及特殊需求，有着不俗的抗菌表现。

### 板材优势 /Plate advantages



#### 环保无醛

不含放射性元素  
是一款良好的环保材料



#### 色彩

经典的纯黑、纯白两色  
及其他各种肌理饰面



#### 高强

抗冲击、耐磨、耐刮擦



#### B1 级防火

拥有良好的耐热性能  
适用于防火限制场所的内装饰



#### 易洁

耐污染，表面易清洁



#### 防霉

拥有良好的耐潮湿性能

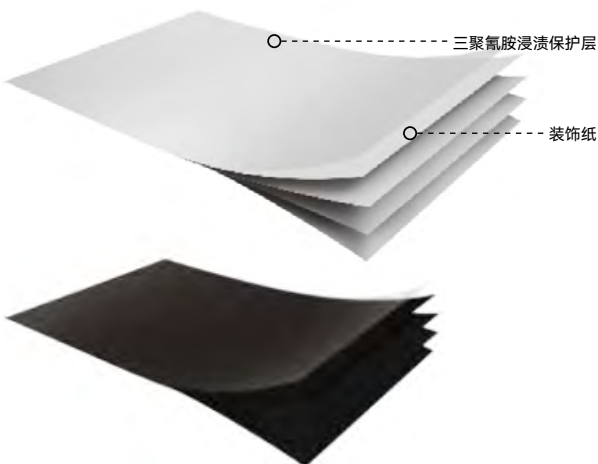

### 规格说明 /Specifications

宽 (w) X 高 (h) mm:	厚 (t) mm:
1220mm*2440mm	(1mm)



## SPC+ 系列 墙面系统

SPC+ 系列 墙面系统 依托圣戈班先进的技术生产线，严格筛选原材料，再经过圣戈班亚太研发中心优化精准配料，精心加工而成。主要原料是优质的天然石粉，故不含任何的放射性元素，是绿色环保无污染的优质原料。整体质地较软加高弹性，所以在抗重物冲击有着不俗的表现，有着良好的弹性恢复力。饰面层更有一层圣戈班特殊加工的透明耐磨层，同时兼具了耐磨损的特点。SPC+ 系列适应场景广泛，是有着 B1 级防火需求场景极佳的选择。

### 板材优势 /Plate advantages



#### 环保无醛

100% 天然优质石粉，不含任何放射性元素



#### 密度

密度为 2-3kg/m<sup>2</sup>



#### 高强

高弹性、抗冲击；  
冲击下有良好的弹性恢复，表面附有特殊的透明耐磨层



#### B1 级防火

B1 级不燃基材  
适用于有防火限制场所的内装饰



#### 耐候

浸水后厚度膨胀检测平均值为 0



#### 色彩

超百种饰面花色可供选择  
木纹、石纹、布艺、皮革、金属等

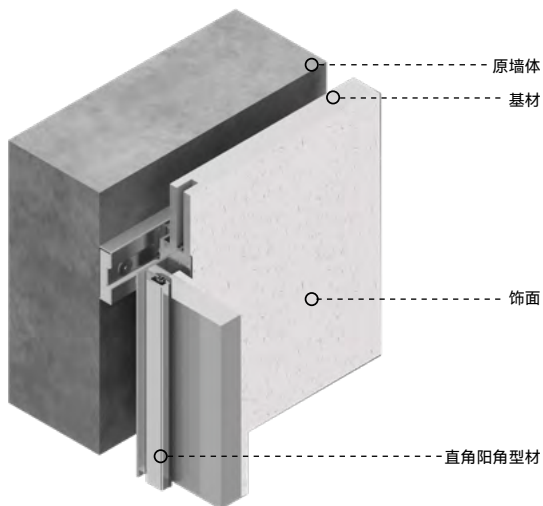

### 规格说明 /Specifications

宽 (w) X 高 (h) mm:	厚 (t) mm:
600mm*2440mm / 600mm*3000mm	(9mm)
1220mm*2440mm / 1220mm*3000mm	(9mm)



## SPC+ 系列 墙面系统<sup>LT</sup>

是一种轻质高强、耐腐蚀性强、安装简便的墙面装饰材料,可以广泛应用于室内外装修、建筑外墙、地铁站装饰和景观等领域。它结合了石材和塑料的优点,具有色彩丰富、美观大方的特点,同时可以提供定制化服务,满足客户的个性化需求。这种环保可持续的建筑材料,不仅提供了实用的建筑解决方案,还具有美学价值,让建筑更加美观、耐用且符合现代环保理念。

### 板材优势 /Plate advantages



**环保无醛**  
E0 级环保



**B1 级防火**  
B1 级不燃基材  
适用于有防火限制场所的内装饰



**防水防潮**  
浸水后厚度膨胀检测平均值为 0



**安装便捷**  
安装简单,方式多种。如:V 缝、直缝

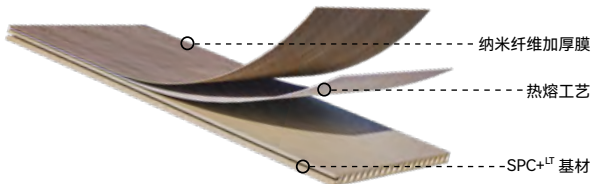

### 规格说明 /Specifications

宽 (w) X 高 (h) mm:	厚 (t) mm:
600mm*2400mm / 600mm*2600mm	(8mm)
600mm*2400mm / 600mm*2600mm	(8.8mm)
600mm*2400mm / 600mm*2600mm	(10mm)
600mm*2800mm / 600mm*3000mm	(8mm)
600mm*2800mm / 600mm*3000mm	(8.8mm)
600mm*2800mm / 600mm*3000mm	(10mm)
600mm*3200mm	(8mm)
600mm*3200mm	(8.8mm)
600mm*3200mm	(10mm)



## WPC 系列 墙面系统

WPC 系列 墙面系统 是一种高分子材料，选用优质的原材料经过圣戈班亚太研发中心优化精准配料，添加高分子防火防水材料，高温压制而成。饰面层采用圣戈班高温覆面或滚涂工艺生产线，多种饰面花色可选。饰面层处理全部采用环保材料，不含任何放射性、刺激性元素；0 碳 0 排放，彻底告别甲醛，即装即应用，真正做到环保速造。

### 板材优势 /Plate advantages



#### 环保无醛

甲醛 / 重金属 未检出  
检验标准: GB/T17657-2013



#### 耐候

吸水尺寸变化率: 横: 0.37%, 纵: 0.33%, 厚: 0.59%  
检验标准: Q/06979184.01-2016



#### 高强

耐热循环系数: 横: 0.03mm, 纵: 0.09mm  
(标准  $\leq 0.5$  mm)



#### B1 级防火

B1 级不燃基材  
检验标准: GB8624-2012



#### 易洁

耐污染, 易清洁



#### 防霉抗菌

防水, 防潮, 不易虫蛀, 不长真菌

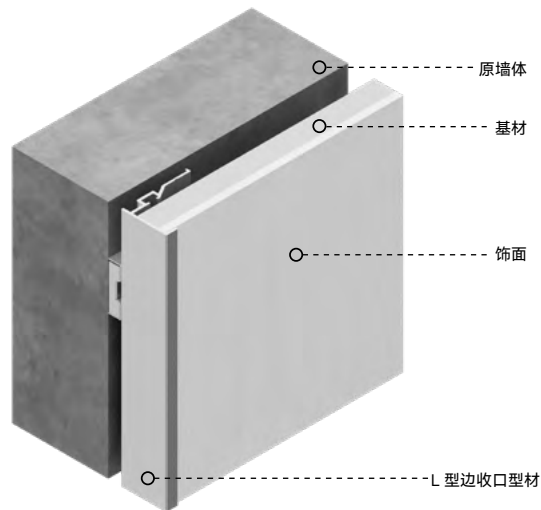

### 规格说明 /Specifications

宽 (w) X 高 (h) mm:	厚 (t) mm:
600mm*2440mm / 600mm*3000mm	(6mm)
600mm*2440mm / 600mm*3000mm	(8mm)
600mm*2440mm / 600mm*3000mm	(9mm)
600mm*2440mm / 600mm*3000mm	(10mm)
1220mm*2440mm / 1220mm*3000mm	(5mm)
1220mm*2440mm / 1220mm*3000mm	(6mm)
1220mm*2440mm / 1220mm*3000mm	(8mm)
1220mm*2440mm / 1220mm*3000mm	(9mm)
1220mm*2440mm / 1220mm*3000mm	(10mm)



## WPC Stone 系列 墙面系统

WPC Stone 系列墙面系统是一种高品质的墙面系统，具有防火、防水、环保等优点。它适用于各种建筑和装饰领域，如住宅、办公室、酒店、学校等。此外，WPC Stone 系列墙面系统的生产过程也符合环保要求。它采用环保材料，不含任何放射性、刺激性元素，符合国家环保标准。同时，该系统的生产过程也具有高效、节能、低耗等优点，符合可持续发展的要求。

### 板材优势 /Plate advantages



#### 环保无醛

甲醛 / 重金属 未检出  
检验标准: GB/T17657-2013



#### 耐候

吸水尺寸变化率: 横: 0.37%, 纵: 0.33%, 厚: 0.59%  
检验标准: Q/06979184.01-2016



#### 高强

耐热循环系数: 横: 0.03mm, 纵: 0.09mm  
(标准  $\leq 0.5$  mm)



#### B1 级防火

B1 级不燃基材  
检验标准: GB8624-2012



#### 易洁

耐污染, 易清洁



#### 防霉抗菌

防水, 防潮, 不易虫蛀, 不长真菌

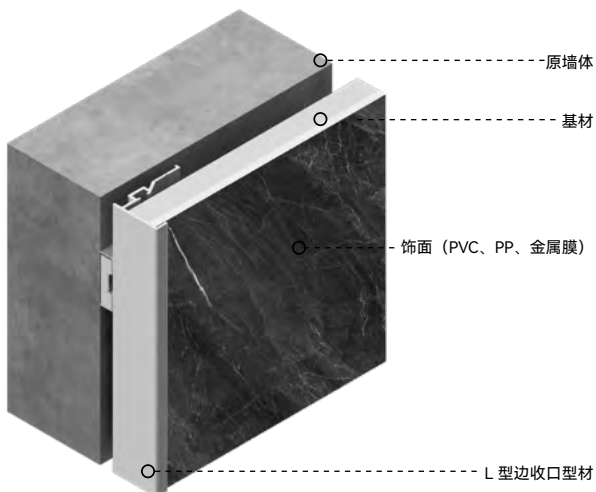

### 规格说明 /Specifications

宽 (w) X 高 (h) mm:	厚 (t) mm:
600mm*2440mm / 600mm*3000mm	(6mm)
600mm*2440mm / 600mm*3000mm	(8mm)
600mm*2440mm / 600mm*3000mm	(9mm)
600mm*2440mm / 600mm*3000mm	(10mm)
1220mm*2440mm / 1220mm*3000mm	(5mm)
1220mm*2440mm / 1220mm*3000mm	(6mm)
1220mm*2440mm / 1220mm*3000mm	(8mm)
1220mm*2440mm / 1220mm*3000mm	(9mm)
1220mm*2440mm / 1220mm*3000mm	(10mm)

◎可复用装配式普通隔墙



## 可复用装配式普通隔墙

可复用装配式普通隔墙是一种新型隔墙，它的部品可以快速、方便地进行安装和拆卸，且可复用回收重新使用；中间填充了两层隔音材料、一层硅酸钙板，具有良好隔音同时还具有隔热、防火、重量轻、强度高、防潮、防霉、环保等性能。广泛应用于办公场所拎包入住、写字楼办公租赁、连锁商业、连锁酒店等可复用需求较高的场景中。

### 隔墙优势 / Partition wall advantage



#### 可复用

型材可复用 5-10 次  
面层可复用 2-3 次



#### 优质防火

B1-A1 防火  
可选不同材质面材



#### 优质隔音

隔音性能 40-50dB



#### 可回收

85% 部件可回收



#### 快速安装

安装简单  
可徒手安装



#### 绿色环保

均为绿色环保材料

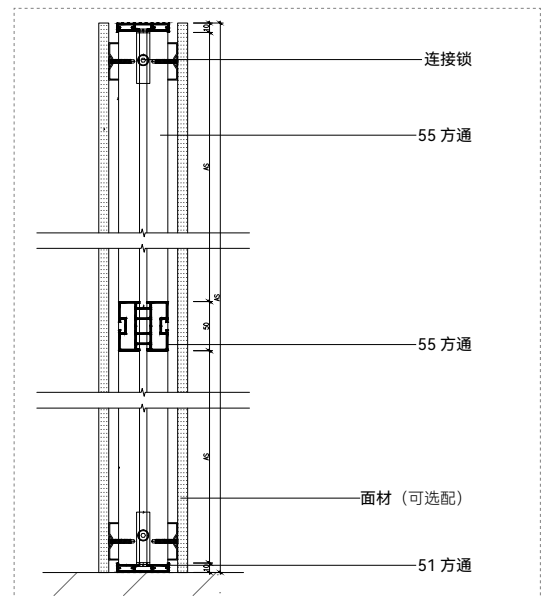
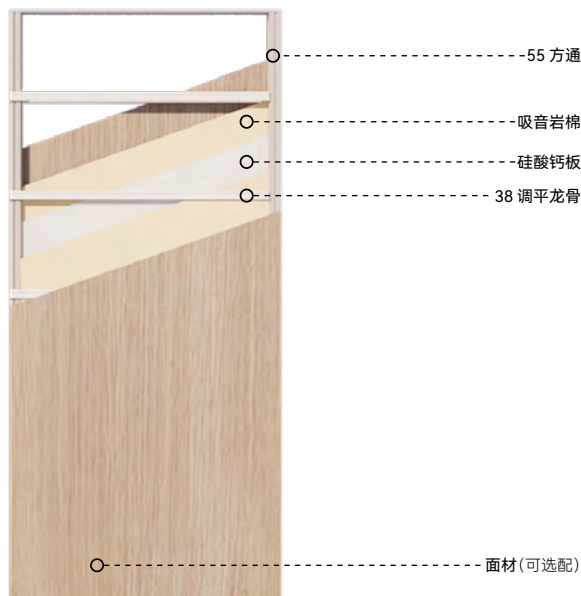



## 可复用装配式高隔音隔墙

可复用装配式高隔音隔墙可以快速、方便地进行安装和拆卸，且可复用回收重新使用；中间填充了两层隔音材料、一层高强度硅酸钙板，具有优质隔音同时还具有隔热、防火、重量轻、强度高、防潮、防霉、环保等性能。广泛应用于办公场所拎包入住、酒店、公寓、别墅、酒店、商场等可复用需求较高的场景中。

### 隔墙优势 / Partition wall advantage



#### 可复用

型材可复用 5-10 次  
面层可复用 2-3 次



#### 优质防火

B1-A1 防火  
可选不同材质面材



#### 优质隔音

隔音性能 50-55dB



#### 可回收

85% 部件可回收



#### 快速安装

安装简单  
可徒手安装



#### 绿色环保

均为绿色环保材料

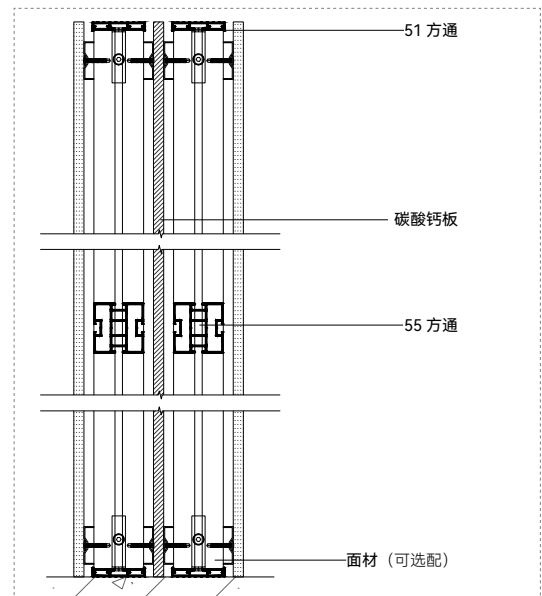



## 特耐系列 可复用一体化隔墙

该系统采用一体化设计，在工厂中预制，结构和装饰都是一体化的，可快速、简便地安装，同时具有优异的隔声和防火性能，能够提供安全、舒适的工作和生活环境。特耐一体化墙面系统采用环保材料制造，符合绿色建筑的要求，同时经过严格的质量控制和耐久性测试，能够长期保持良好的性能和使用效果。它是一种理想的建筑墙面解决方案，为您的建筑项目提供持久耐用的室内分隔效果。适用于办公室、会议室、餐厅、工业建筑、公共设施等场所的室内分隔。

### 隔墙优势 / Partition wall advantage



**绿色环保**  
均为绿色环保材料  
E0 级



**优质防火**  
可选不同材质面材  
B1-A1 防火



**优质隔音**  
隔音性能达  
35-55dB



**可回收复用**  
75% 可复用  
85% 部件可回收



**密度**  
密度为 25-51kg/m<sup>2</sup>



**快速安装**  
安装简单  
可徒手安装

特耐系列	饰面 (可选配)	面板	龙骨	填充	厚度 (mm)	隔音 (dB)	面密度 (kg/m <sup>2</sup> )	耐火性能 (min)	抗冲击 (次)	单点吊挂力 (kg)	尺寸 (mm)
50 一体化隔墙	①高密度板素面 (后贴壁纸或墙布) ② PVC 包覆膜 / 哑光油漆 (纯色) ③准分子肤感涂装 (纯色) ④ HPL 防火板饰面 (木纹 / 布纹 / 纯色)	零醛防水高密度饰面板	850 密度龙骨	400 密度 AK 板芯	50	35	25	60	50	25	(H) 2700/3000/3200 * (W) 600/900
120 分拆式隔墙				/	120	42	37	60			
150 分拆式隔墙	①隔墙素面 + 现场壁纸或墙布 ② HPL 防火板 (木纹 / 布纹 / 纯色) ③准分子肤感涂装 (纯色) ④科技木皮油漆	AK 饰面板	1200 密度龙骨	吸音岩棉板	150	50	42	90	100	45	H) 2700/3000 * (W) 900
150 分拆式高隔音隔墙				15600 AK 板 + 吸音岩棉板	150	55	51				





国家建筑节能检测中心  
National Energy Conservation Testing Center  
建筑节能检测中心 建筑节能检测资质证书  
Building Energy Conservation Testing Center Building Energy Conservation Testing Qualification Certificate

报告编号: JGJ107-2017-001	工程名称: 圣戈班特耐系列一体化标准规格-50mm厚隔墙	检测机构: 国家建筑节能检测中心
委托单位: 圣戈班特耐系列一体化标准规格-50mm厚隔墙	检测日期: 2017年10月	检测地点: 圣戈班特耐系列一体化标准规格-50mm厚隔墙
检测项目: 隔声性能检测	检测标准: GB 19961-2015	检测人员: 张永强
检测结果: 隔声性能符合设计要求	检测结论: 合格	检测单位: 国家建筑节能检测中心

隔音性能检测报告

国家消防产品质量检验中心  
National Fire Product Quality Inspection Center  
消防产品质量检验中心 消防产品质量检验资质证书  
Fire Product Quality Inspection Center Fire Product Quality Inspection Qualification Certificate

报告编号: JGJ107-2017-002	工程名称: 圣戈班特耐系列一体化标准规格-50mm厚隔墙	检测机构: 国家消防产品质量检验中心
委托单位: 圣戈班特耐系列一体化标准规格-50mm厚隔墙	检测日期: 2017年10月	检测地点: 圣戈班特耐系列一体化标准规格-50mm厚隔墙
检测项目: 防火性能检测	检测标准: GB 15629-2015	检测人员: 张永强
检测结果: 防火性能符合设计要求	检测结论: 合格	检测单位: 国家消防产品质量检验中心

防火性能检测报告

特耐系列一体化标准规格 -50mm 厚隔墙

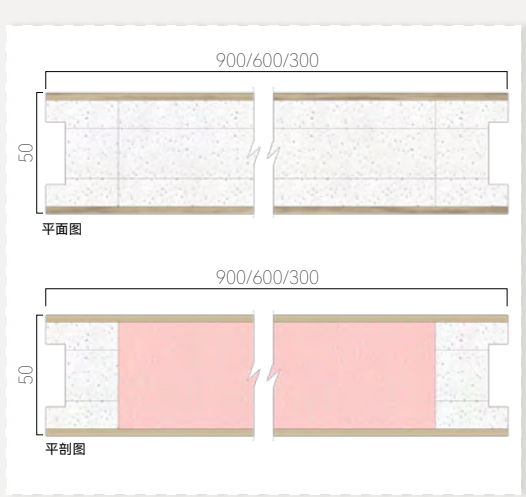
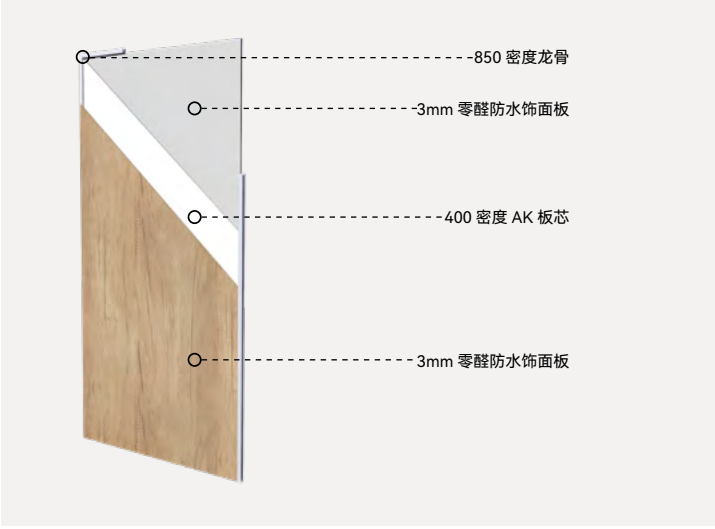

特耐系列一体化集成管线 -50mm 厚隔墙

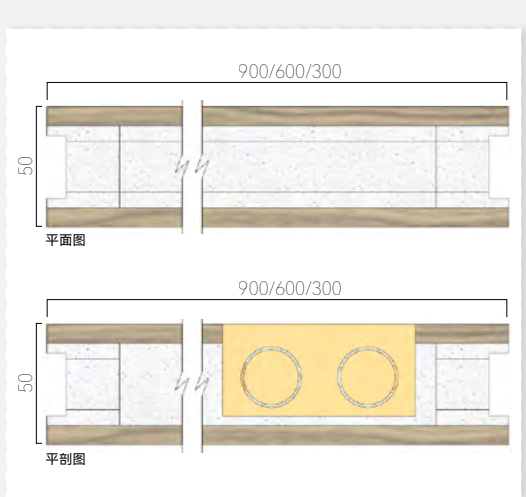
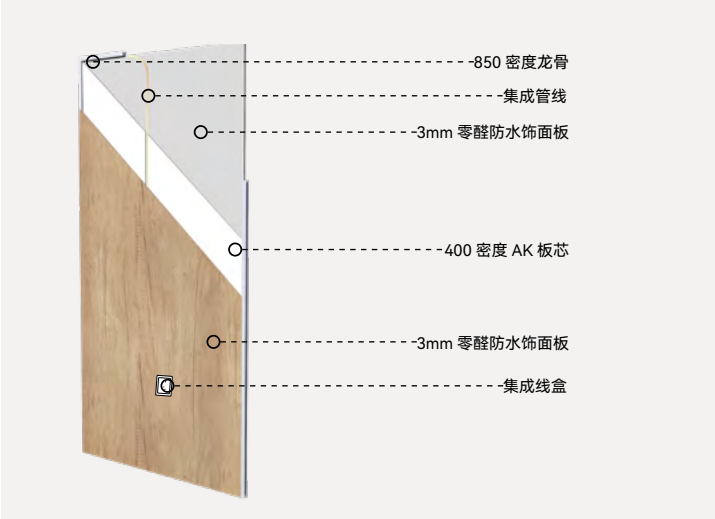

特耐系列分拆式 -120mm 厚隔墙

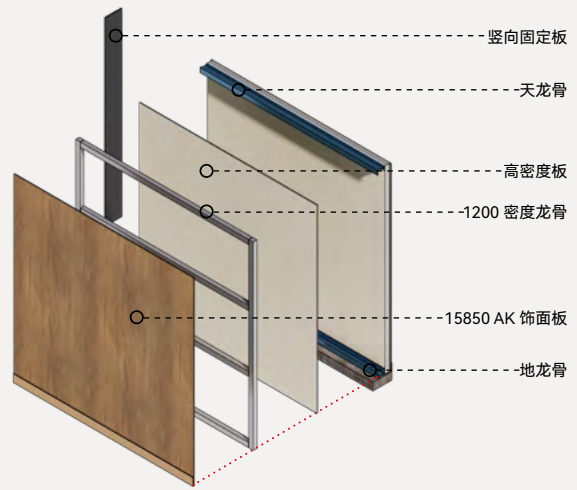

特耐系列分拆式 -150mm 厚隔墙

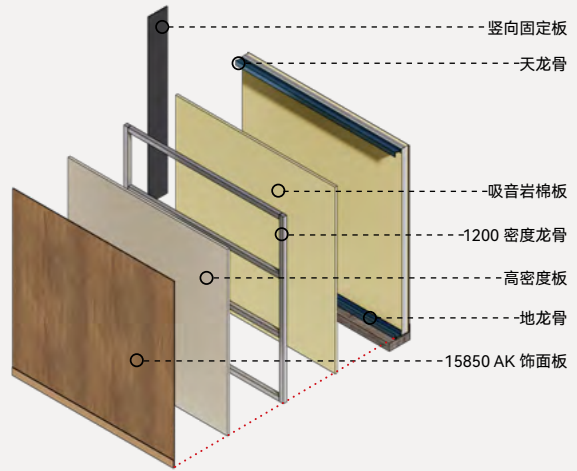

特耐系列分拆式 - 高隔音 150mm 厚隔墙

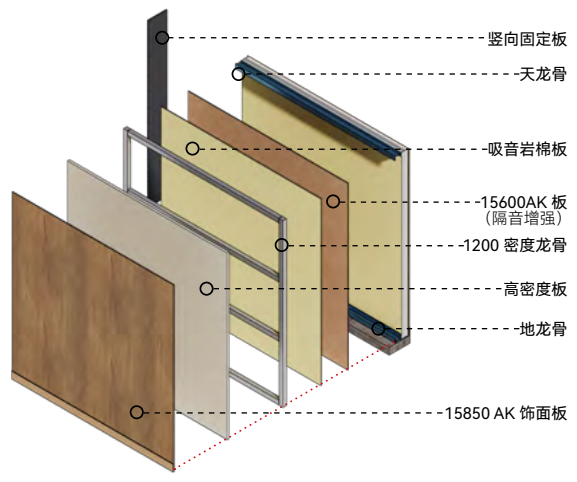

## ENF级基材

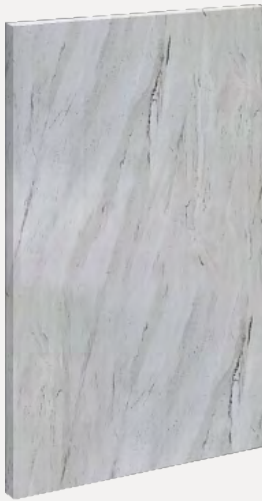

### 哈比特®系列基材



采用胶凝技术及纤维增强材料的高强实芯板材，其原材料主要包括专利胶凝物质、矿物纤维和石膏。这种板材的内部结构结合非常致密，具有优质木工板同等的操作性能，如稳定的气钉和螺钉握钉能力，可任意裁切和拼接等。



#### ENF级环保无醛

送检 0.3mg/L，抽检 0.5mg/L  
植物胶凝技术



#### A2级防火

A2级不燃基材



#### 超强握钉力

2颗气钉，可轻松提起 20KG 的水桶  
10mm > 400N/12mm > 500N



#### 耐候

浸水后厚度膨胀检测平均值为 0

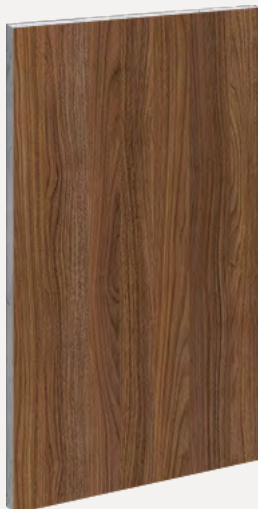

### AK系列基材



采用多元镁基胶凝体系，通过铺网灌模工艺生产制作而成的新型材料。后经自然养护在结构内部形成蜂窝状封闭泡沫孔结构。具有防火隔热，无醛无毒，加工便捷等特点。



#### ENF级环保无醛

产烟毒性 AQ1 级  
甲醛等级 ENF 无醛级



#### A1级防火

耐火极限温度，最高达 1200 °C  
导热系数最低 0.26W/(m·K)



#### 良好隔音

单板隔音最高 38dB



#### 轻质发泡结构

体积密度为 0.4-0.85g/cm³



## Reusable fences 可复用围挡

可复用围挡是一种可以快速搭建和拆卸的围挡，由方通与冲孔铝板等部件排列组成。适用于施工现场临时围挡保护、施工区域划分或短期租赁使用，特殊防爆需求可加钢板。

### 隔墙优势 / Partition wall advantage

- 

**快速安装**  
安装简单  
可徒手安装
- 

**可复用**  
100% 可复用  
可复用 8-15 次
- 

**无需破坏地面**  
搭建围挡  
无需破坏地面固定
- 

**高强**  
抗冲击  
高强度结构
- 

**可定制**  
外观围挡定制  
规格定制
- 

**品质保障**  
源头厂家  
售后无忧

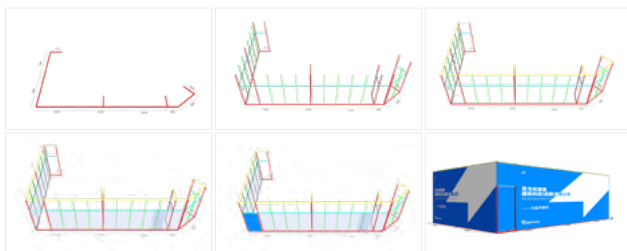
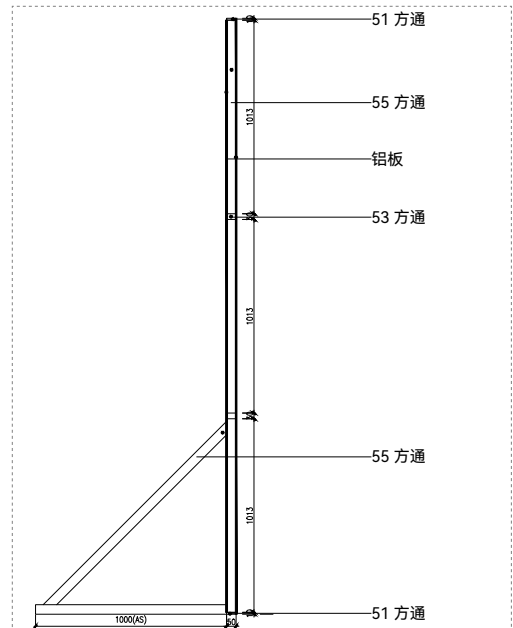
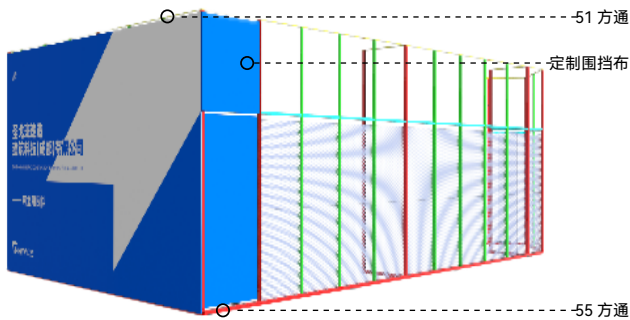



## Active fencing 活动围挡

活动围挡是一种可以快速搭建和拆卸的可移动围挡，由多个可装配部件排列组成。具有安装方便、转场移动便捷、可售可租等优点。同时可根据需求选择单开门或双开门。适用于展会划分、场馆划分、活动围挡、防爆等需求场景。

### 隔墙优势 / Partition wall advantage



**快速安装**  
安装简单  
可徒手安装



**可移动**  
灵活移动  
可选配移动方案



**可复用**  
100% 可复用



**耐候**  
抗紫外线、防水防潮



**面层选配**  
可根据场景需求  
灵活选配面层



**单 / 双开选配**  
可根据场景需求  
选配单开门 / 双开门

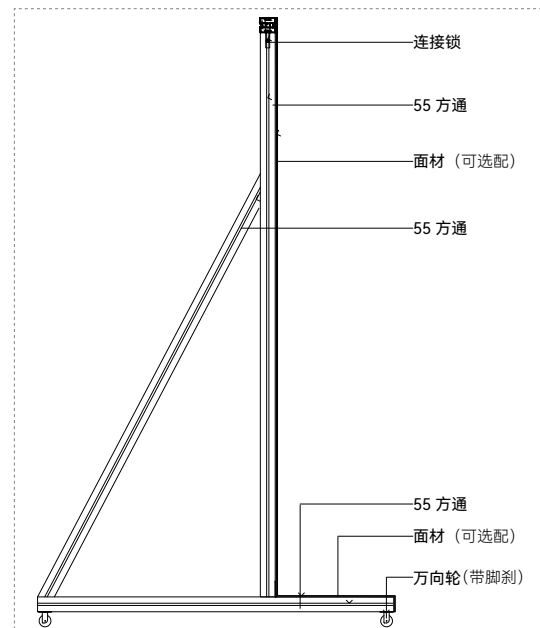
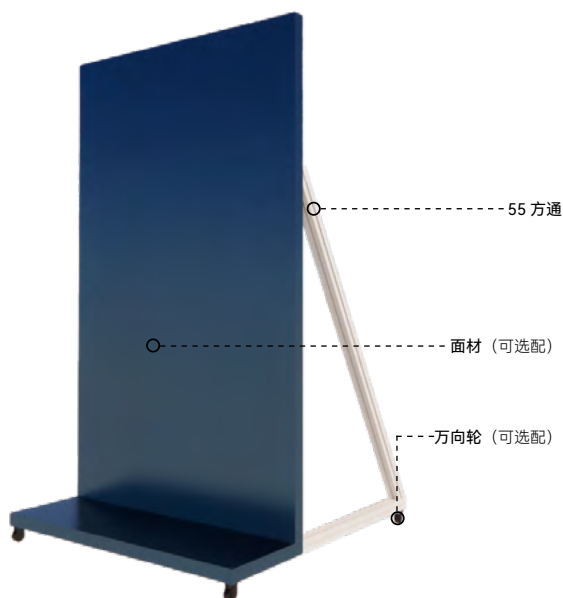



/// 板材压条组合

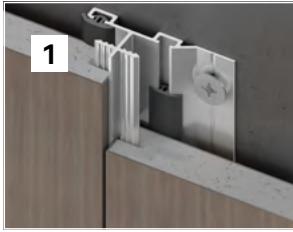

1 十字凹缝压条节点

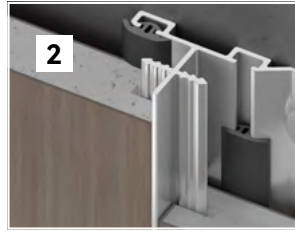

2 十字平缝压条节点

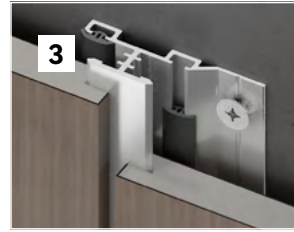

3 水缝压条节点

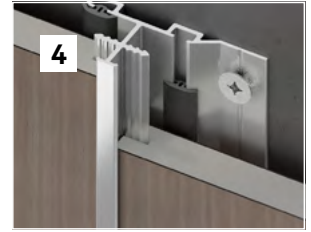

4 外包压条节点

/// 踢脚组合



1 发光踢脚节点



2 踢脚节点

/// 顶收口组合



1 标准顶收口节点



2 挂镜线顶收口节点

/// 阳角组合

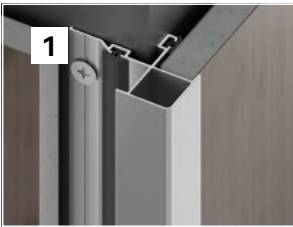

1 直角阳角节点



2 弧型阳角节点



3 极窄阳角节点

/// 边收口组合



1 L字边收口节点图

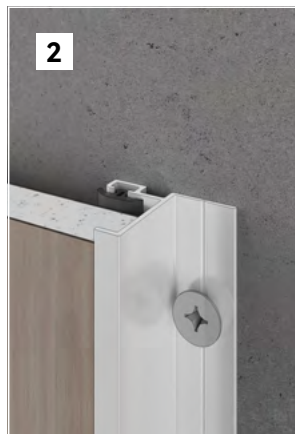

2 丁字边收口节点图

/// 套口组合



3 门套节点图

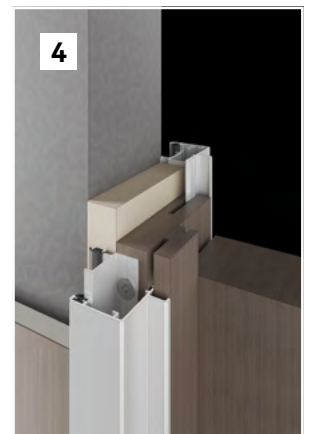

4 哑口套收口节点图

## 装饰配件 / Decorative accessories

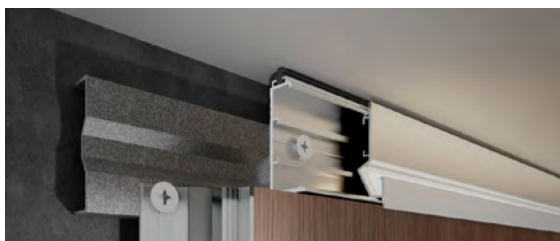

### 照明一体化顶收口线条

整合线性照明的墙板顶收口线条，出光角度经过精确计算，光线通过天花板反射进行间接照明，柔和无炫光。可搭配智能控制模块进行色温、亮度甚至颜色调节。



照明



氛围



### 照明一体化装饰线条

整合线性照明的墙板装饰线条，可搭配智能控制模块进行色温、亮度甚至颜色调节的墙面装饰线条。



照明



氛围



### 照明一体化踢脚线条

整合线性照明的墙板踢脚收口线条，出光角度经过精确计算，光线通过地面反射进行间接照明，柔和无炫光。可搭配智能控制模块进行色温、亮度甚至颜色调节。



照明



氛围



### 造型墙面收口线条

整合造型收口，满足多项功能模块嵌入需求的同时，可搭配线性照明，适用于背景墙。



照明



氛围



### 挂镜线一体化顶收口线条

整合挂镜线功能的顶收口线条，可不破坏墙面的同时挂装装饰画，实现轻松替换和自由调整悬挂位置的功能。



自由调节



12kg/m 承重

## 型材颜色选择 / color selection

标号 :6063-T5, 喷砂电泳 / 壁厚 1.0~1.5mm

冰川银

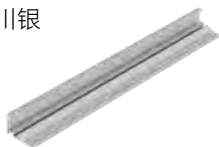

雅黑



香槟金



尊金





1 26W 型顶收口节点

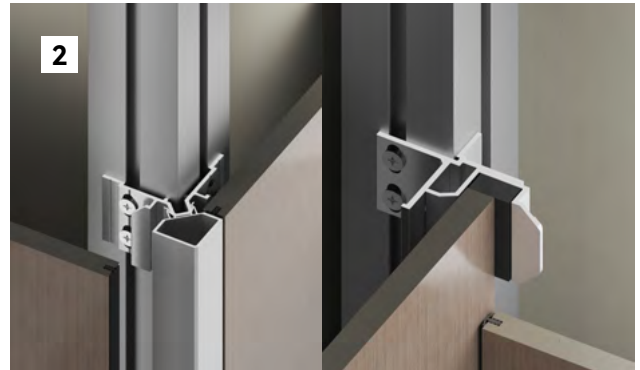

2 阴阳角节点



3 50 平踢脚与石材地面节点

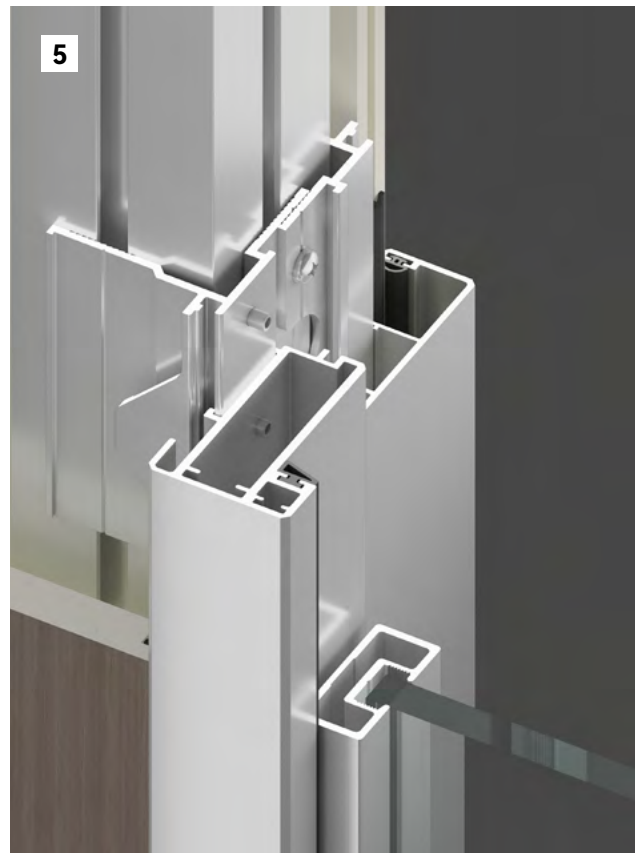

5 极窄边框门扇节点



4 独立垭口套节点

型材颜色选择 / color selection

标号 :6063-T5, 喷砂电泳 / 壁厚 1.0~1.5mm

冰川银

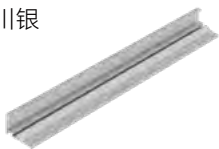

雅黑



香槟金



尊金





## 装饰配件 / Decorative accessories



### 照明一体化顶收口线条

墙面顶端的发光需求日益增加，INSPACE 墙面产品将光源组件与顶收口进行一体化设计，无论作为亮度照明还是氛围光源都能满足外观与亮度需求。



照明



氛围



### 智能运控开关模块

BUS 系统中独立设计的开关插座模块，能够更好配套背挂式的墙面安装，也能充分保障开关插座在墙面的美观与整体性。



智能中控



便捷



### 可替换功能组件

INSPACE 专为墙面功能性开发了插件类挂钩类等多种功能组件，不但能直接增加置物隔板也可直接使用挂钩，更能在多种功能中自由组合切换。



可替换



便捷



### 挂镜线一体化顶收口线条

通过与顶收口适配的顶挂钩悬挂方式，海报、版画等墙面装饰不在需要粘贴或铆钉破坏墙面进行安装，就可以轻松替换和自由调整悬挂位置。挂钩最大承重达到 12 公斤。



自由调节



12kg/m 承重



### 入墙式插座模块

BUS 系统中独立设计的开关插座模块，能够更好配套背挂式的墙面安装，也能充分保障开关插座在墙面的美观与整体性。



安全



多功能



### 入墙式疏散指示牌

入墙式疏散指示牌，避免了传统的顶悬挂与外粘贴安装方式，不但更安全实用也美观大方，充分满足设计需求。



安全



美观



## 连锁酒店 / HOTEL CHAINS

酒店走廊、酒店楼梯间、酒店大堂等酒店空间都需要满足 A 级基层以及 2 小时的防火时限需求。INSPLACE 建议无窗场景采用 双层石膏板防火隔断并添加**美耐系列基层饰面**。连锁酒店与公寓客房内仅需 B1 基层，**SPC+ 系列**是有相关防火需求的客户最佳选择。



酒店电梯厅



酒店走廊



酒店大堂



酒店客房

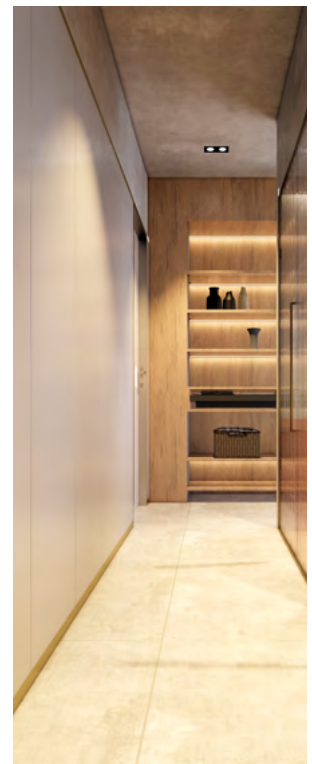

走道



酒店大堂/Hotel lobby



酒店走廊/Hotel corridors



酒店电梯厅/Hotel elevator hall



酒店过道/Hotel aisle



酒店餐厅入口/Hotel restaurant entrance



## 酒店客房/Hotel room

### SBS 墙面系统

系统完整，安装简单，安全，可再利用。  
该系统整合了设备功能模块，扩展性高。

\* 产品详询客服或经销商

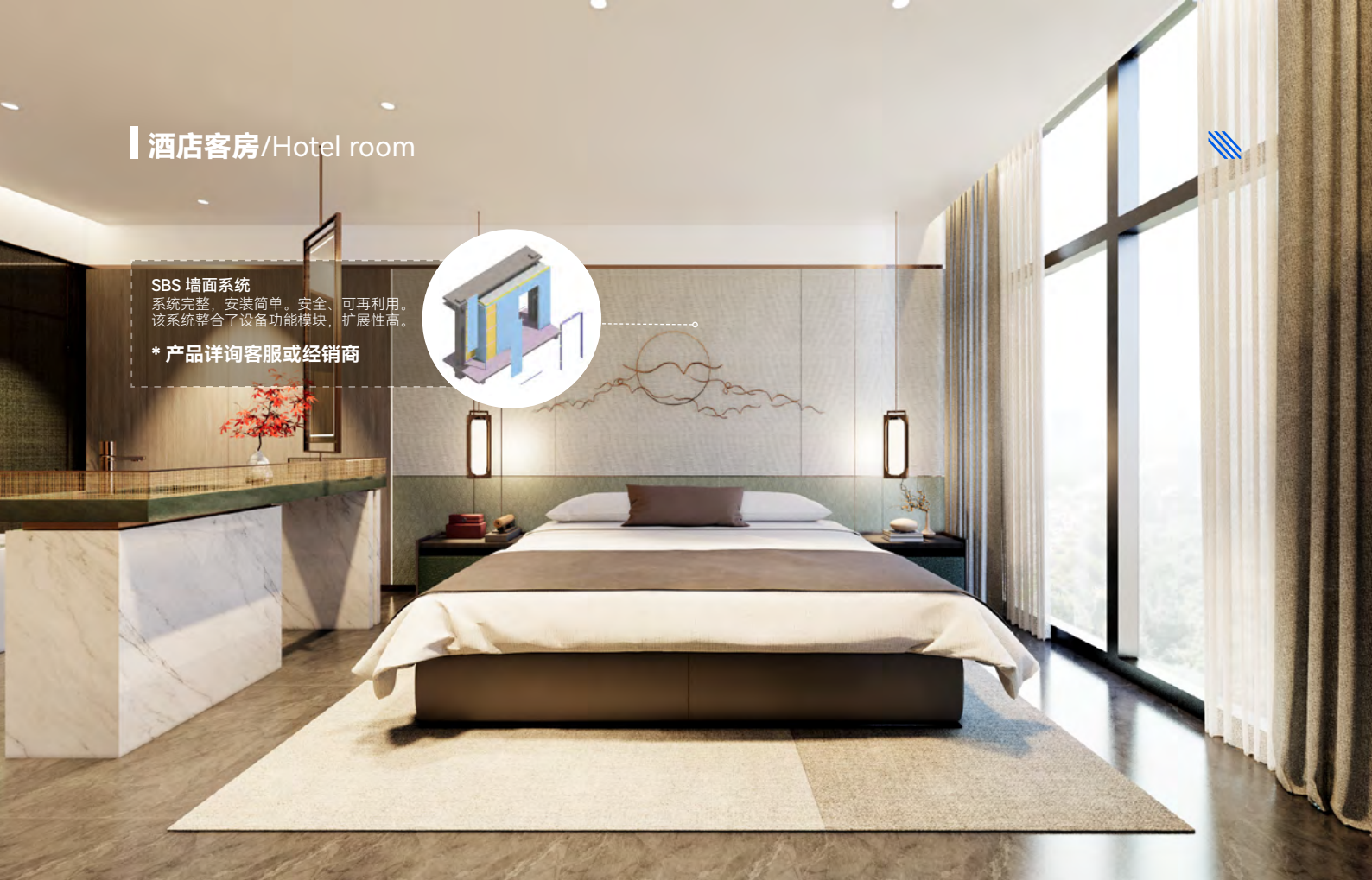

## 酒店客厅/Hotel living room

◎ 模块化电视背景墙



◎ 模块化沙发背景墙



## 酒店客房/Hotel room



高隔声墙体做法  
三层石膏板双层岩棉 隔声(58-62dB)

\* 产品详询客服或经销商



## 浴室干区/Hotel bathroom



酒店浴室 采用美耐系列 墙面系统  
具有高效的防水性、抗老化性。

\* 产品详询客服或经销商

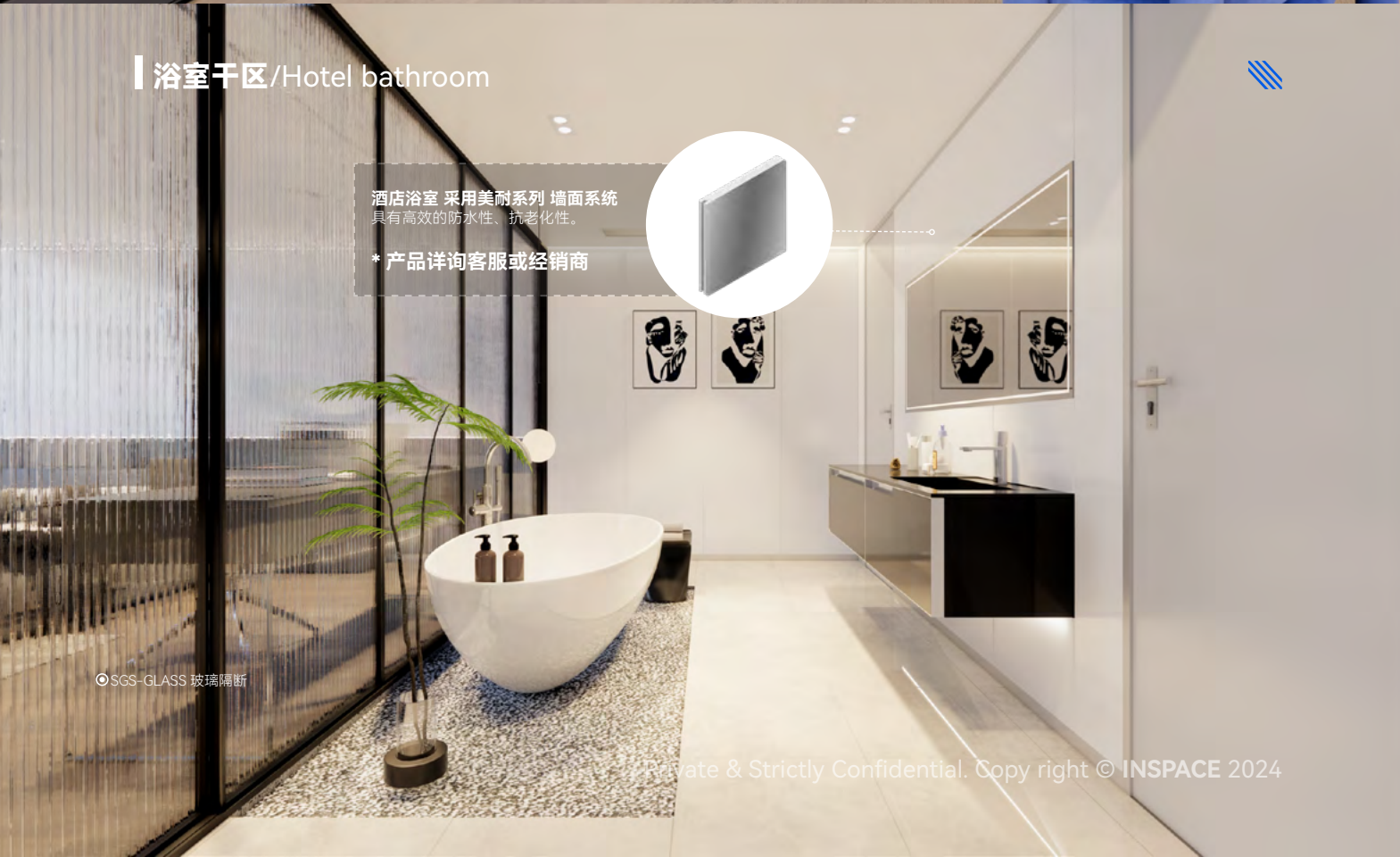



## 餐饮 / CHAIN CATERING

烧烤或火锅类的餐饮行业前厅也会使用 A2 级基层，可使用**美耐系列** 墙面系统，A 级可选择**特耐系列**，若仅需 B1 级前厅可考虑更换其他板材。餐饮行业后厨需使用 A2 级及以上防火需求基材，部分与明火接触的面层更需要直接附上金属面层。**SPC+ 系列**适用于餐饮前厅或门店中比较常见的一款基层板材，能够满足 B1、B2 级防火需求。



餐饮前厅



餐饮后厨



餐饮门店

餐饮包间/Private dining rooms



特耐系列 墙面系统

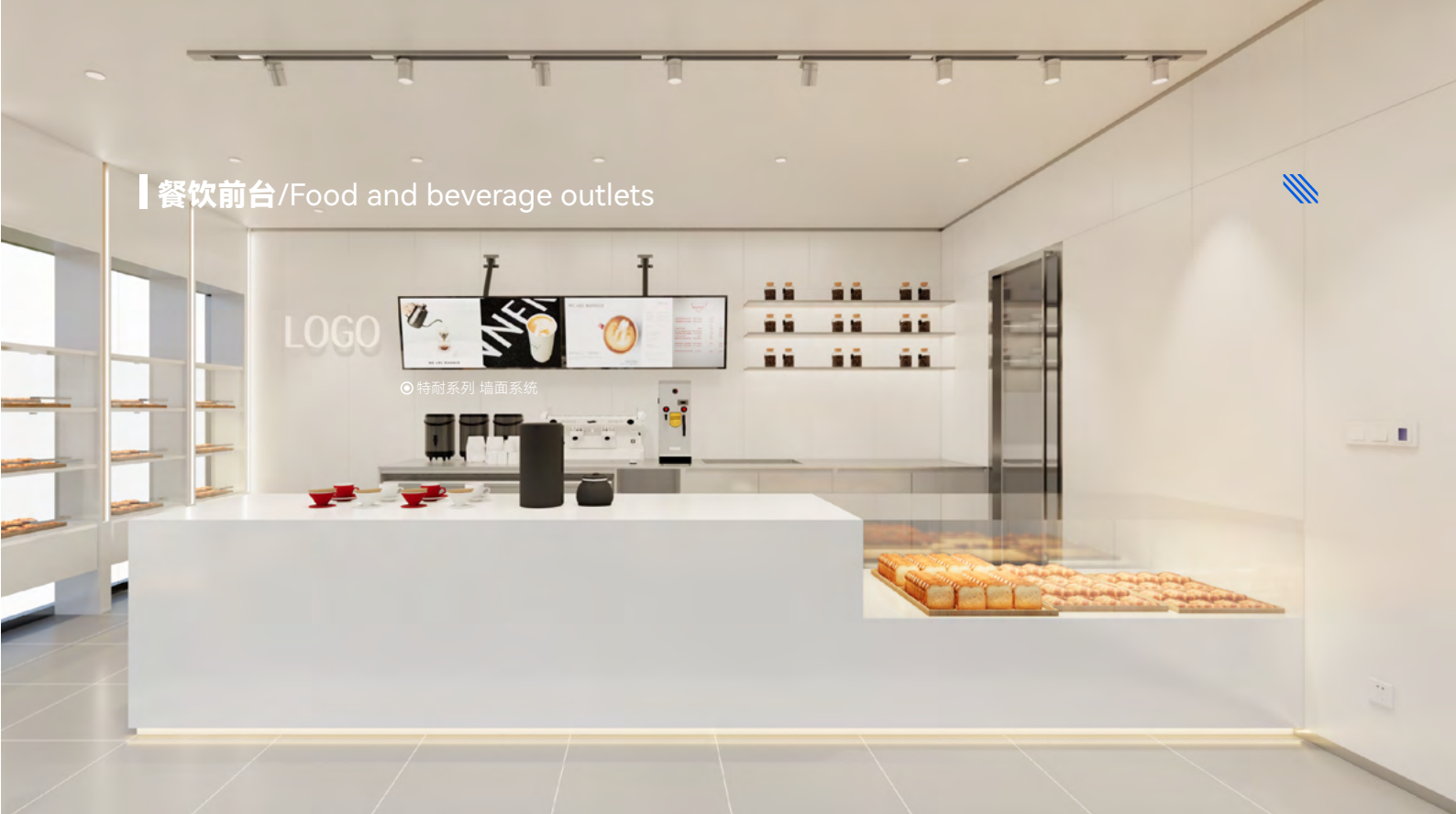

餐饮前台/Food and beverage outlets

◎ 特耐系列 墙面系统



餐饮前厅/Dining lobby



后厨走道/Back kitchen walkway



餐饮后厨/Catering back kitchen

◎ 圣戈班模块化后厨

INSPLACE 特耐系列 墙面系统 适用场景广泛，连锁餐饮，前厅，大堂、包间、走廊过道、后厨等均可使用。



## 餐饮走廊/Dining corridor

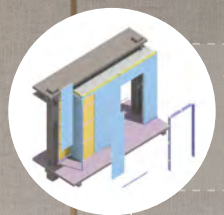

### SBS 墙面系统

系统完整，安装简单，安全，可再利用。  
该系统整合了设备功能模块，扩展性高。

\* 产品详询客服或经销商



## 办公 / OFFICE

办公空间中的走廊与通道区域有 A 级防火需求可采用美耐系列。部分设计师也会将办公空间设计成 A 级防火，美耐系列将会是极佳的选择。SPC+ 系列 作为 B1 级板材能够满足除防火隔断外的所有办公空间的室内需求。WPC 系列 B1、B2 级板材能够满足除防火隔断外的所有办公空间的室内需求。



办公空间

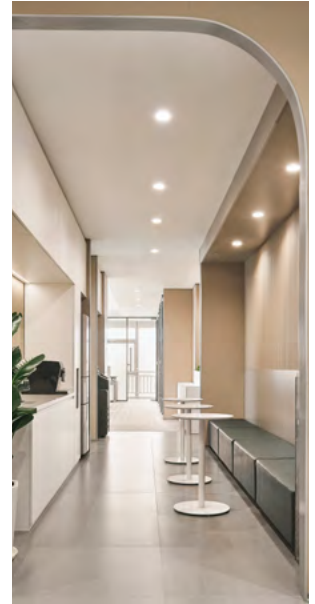

共享空间



前台接待



展示过道

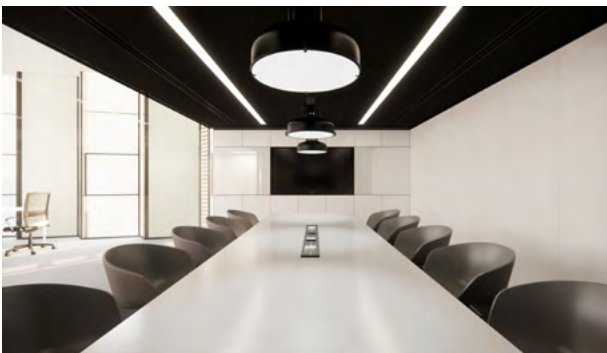

分户隔墙



会议培训



开放办公/Open office

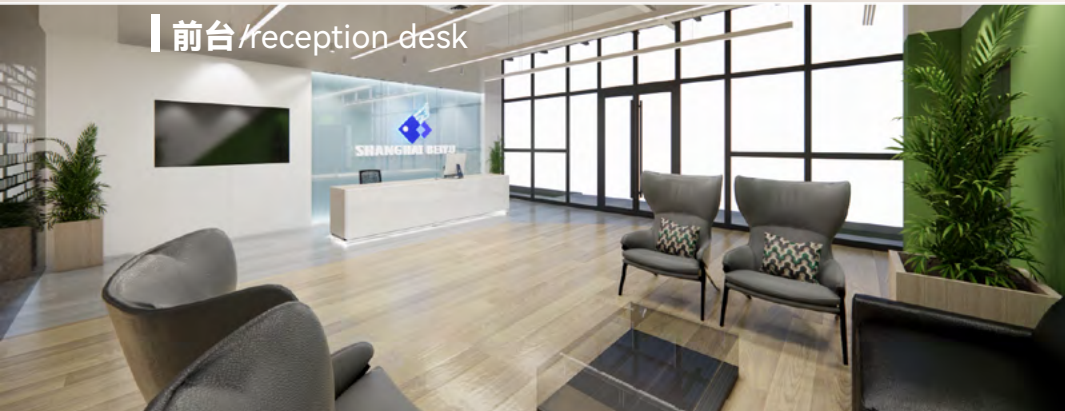

前台/reception desk



小会议室/conference room



接待区/Reception area



办公室/office



洽谈室/Negotiation room



大会议室/Large meeting room

# 开放办公/Open office

SPC+ 系列 墙面系统



## 洗手间/toilet



洗手间 采用 SPC+ 系列 墙面系统  
具有高效的防水性、抗老化性。

\* 产品详询客服或经销商

## 接待区/Reception area



## 小会议室/conference room



## 经理室/Manager's room



## 洽谈室/Negotiation room



## 大会议室/Large meeting room

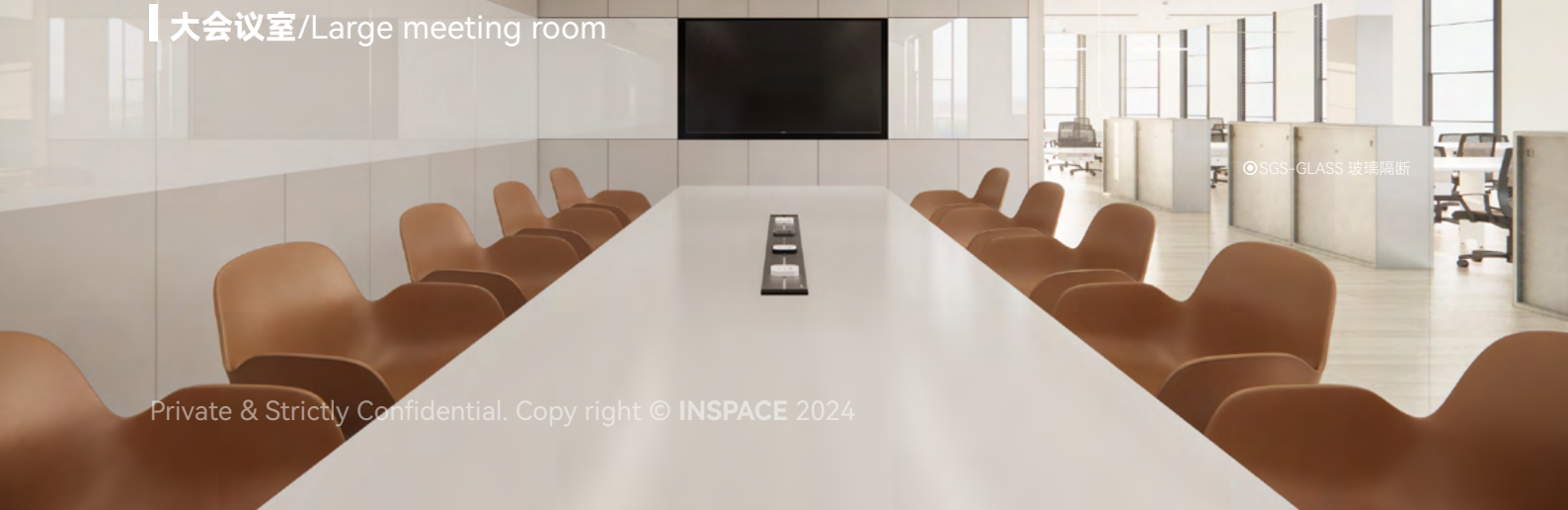

SGS-GLASS 玻璃隔断

## 开放办公/Open office



架空式地坪

## 接待区/Reception area



## 小会议室/conference room



## 茶水区/Pantry area



## 经理室/Manager's room

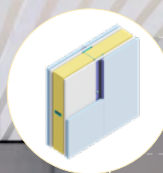
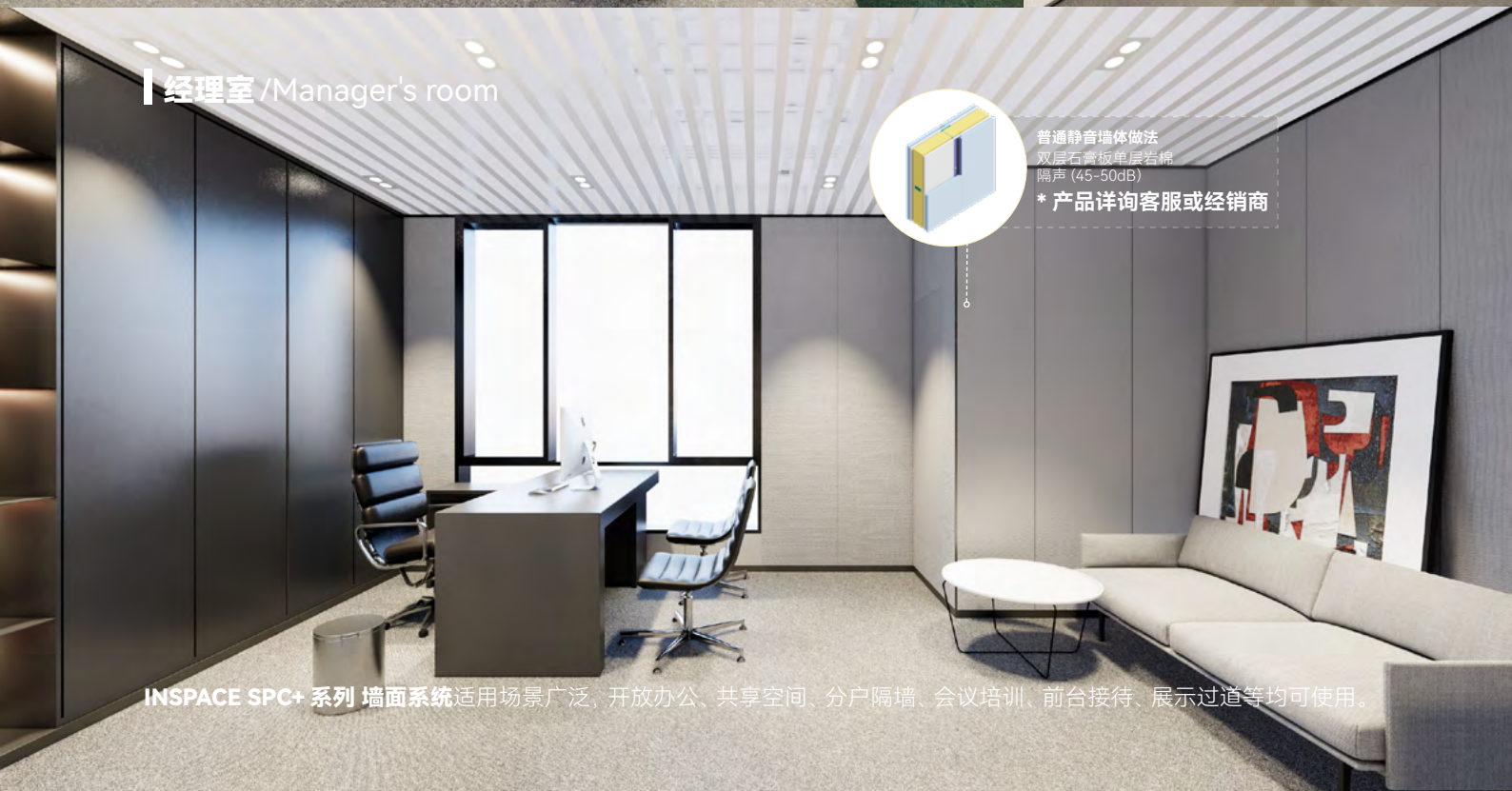

普通静音墙体做法  
双层石膏板单层岩棉  
隔声 (45-50dB)

\* 产品详询客服或经销商

INSPACE SPC+ 系列 墙面系统适用场景广泛, 开放办公、共享空间、分户隔墙、会议培训、前台接待、展示过道等均可使用。



## 城市更新 / URBAN RENEWAL

楼宇大堂与走廊通道区域为 A 级防火需求 美耐系列 为性价比最高的基层。在保障房与城市更新适用中 美耐系列 也将作为 A 级防火的基层选择。特耐板饰面层是高端楼宇大堂的最好选择。WPC 系列 能够满足大部分 B1 级防火需求场景。



保障住房



公寓包租



楼宇大堂



走廊过道



城市更新



市政服务



共享空间



公寓休息区 / The apartment has a seating area



餐吧 / Eat bar



公寓会客区 / Apartment sitting area

## 公寓 客厅 / Apartment living room



普通静音墙体做法  
双层石膏板单层岩棉  
隔声 (45-50dB)  
\* 产品详询客服或经销商

## 公寓 卧室 / Apartment Bedroom

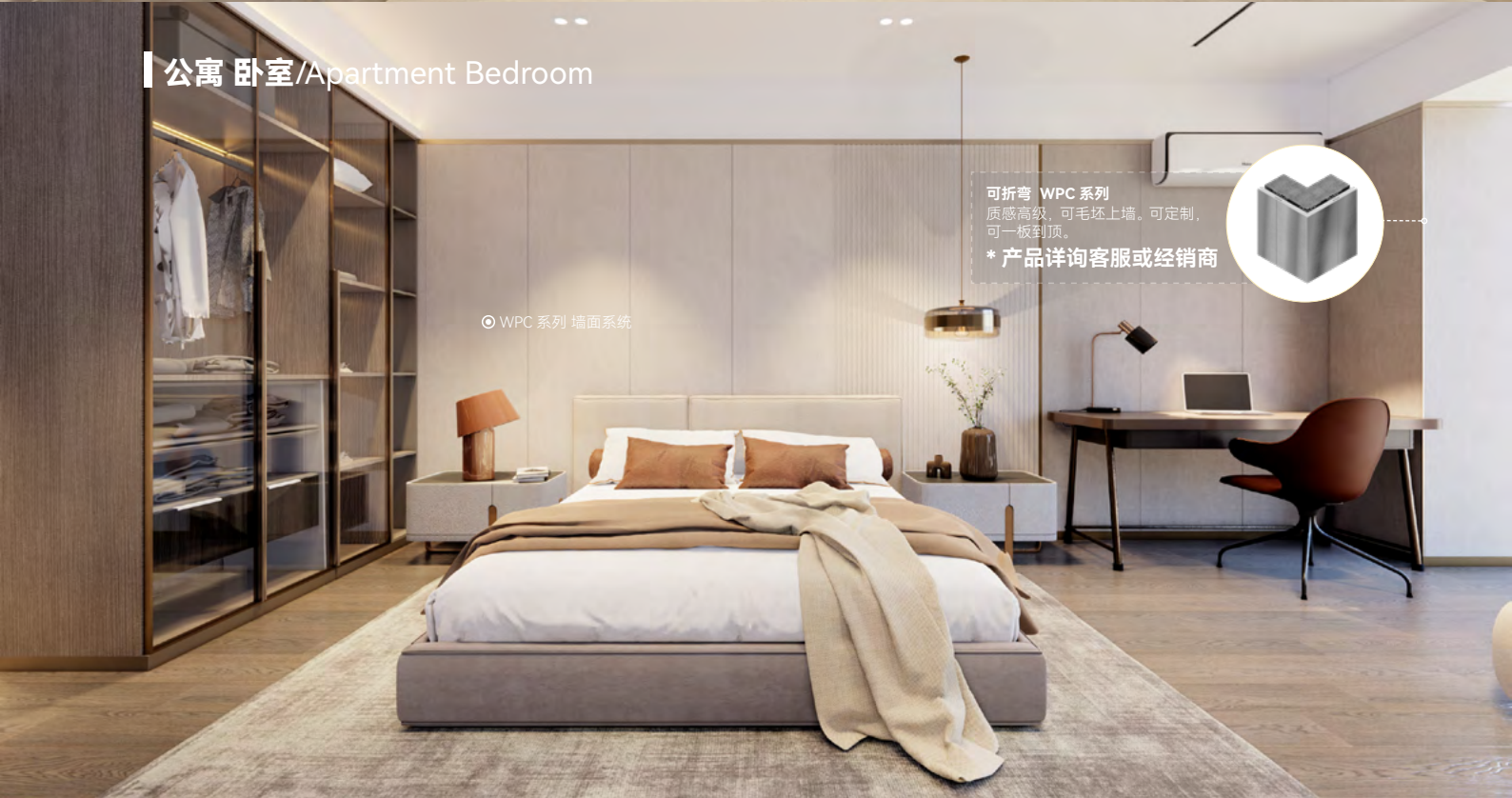

可折弯 WPC 系列  
质感高级, 可毛坯上墙。可定制,  
可一板到顶。  
\* 产品详询客服或经销商

◎ WPC 系列 墙面系统

## 公寓 卫生间 / Apartment Toilet



Private & Strictly Confidential. Copy right © INSPACE 2024

架空式防水地坪◎

## 公寓 厨房 / Apartment kitchen





# 公寓大堂/Apartment lobby



可粘贴包覆 科耐系列  
质感高级，可毛坯上墙。可定制，  
可一板到顶。  
\* 产品详询客服或经销商

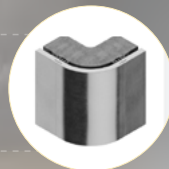

多种样式可选



背挂



包覆

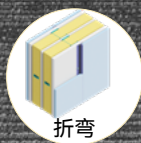

折弯



贴面

INSPACE WPC 系列 墙面系统 适用场景广泛，公寓包租、保障住房、楼宇大堂、市政服务、城市更新、共享空间、走廊过道等均可使用。



## 康养 /WELLNESS

AWC 系列 墙面系统饰面层拥有优秀的抑菌能力，与美耐系列 基层结合是最为医疗康养类客户的极佳选择。AWC 系列基层拥有更长的使用时间和强度，是大型医疗客户最常用的基层板材。SPC+ 系列适用于康养诊所中 B1 基层需求的区域使用。SPC 系列 B1、B2 级板材能够满足除无防火需求的诊所区域。



康养前台



康养诊所



## 医院走廊/Hospital corridors

◎ AWC 系列 墙面系统



## 医院走廊/Hospital wards

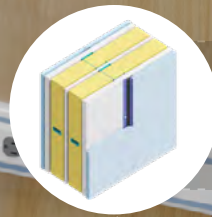

高隔声墙体做法  
三层石膏板双层岩棉 隔声 (58-62dB)  
\* 产品详询客服或经销商



## 医院大厅/Hospital lobby

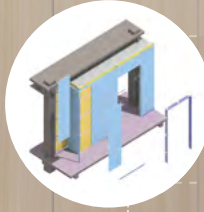

SBS 墙面系统  
系统完整，安装简单，安全，可再利用。  
该系统整合了设备功能模块，扩展性高。

\* 产品详询客服或经销商

1F

2 挂号窗口

3 收费窗口

4 药房窗口

SGS-GLASS 玻璃隔断

## 医院门诊/Outpatient



AWC 系列 墙面系统



医院护士站 / Hospital nurse station

AWC 系列 墙面系统



医院电梯厅 / Hospital elevator hall

INSPACE AWC 系列 墙面系统 适用场景广泛, 医院、病房、康养、诊所、餐饮后厨等均可使用。

## 更多花色选择 / More Surfaces



### 金属 / METAL



### 木纹 / WOOD

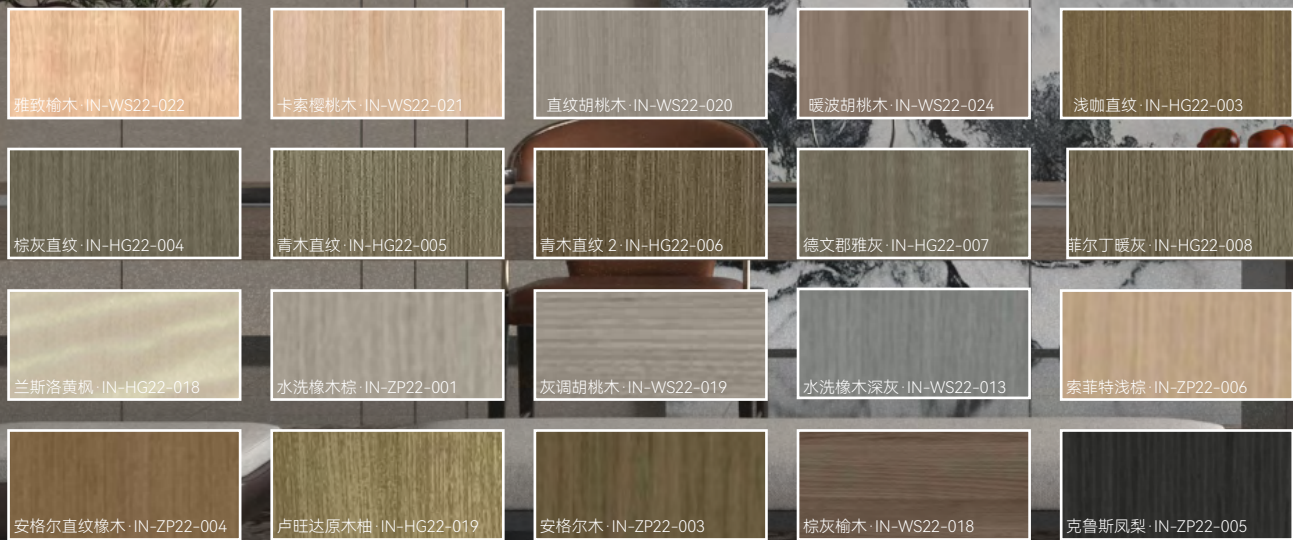

### 皮纹 / SKIN



## 亲肤 /SOFT TOUCH

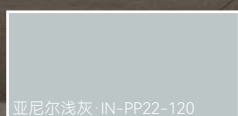

亚尼尔浅灰 IN-PP22-120

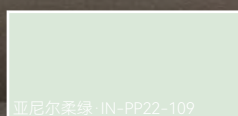

亚尼尔柔绿 IN-PP22-109



亚尼尔暖灰 IN-PP22-123

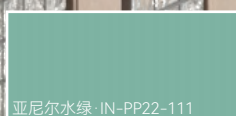

亚尼尔水绿 IN-PP22-111

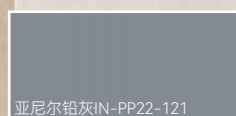

亚尼尔铅灰 IN-PP22-121

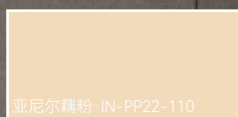

亚尼尔藕粉 IN-PP22-110



亚尼尔柔粉 IN-PP22-112

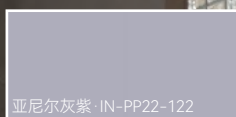

亚尼尔灰紫 IN-PP22-122

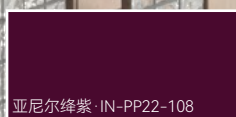

亚尼尔绛紫 IN-PP22-108

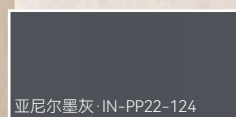

亚尼尔墨灰 IN-PP22-124

## 石纹 /STONE



布谷云白石 IN-WS22-033



灰咖云石 IN-WS22-036

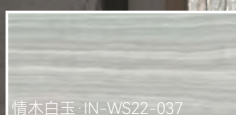

清木白玉 IN-WS22-037

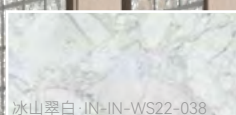

冰山翠白 IN-WS22-038



桃花砾岩 IN-WS22-039



棕咖烟晶 IN-WS22-041



水磨云理 IN-WS22-042



灰水水墨 IN-WS22-043



黑咖金花 IN-WS22-044

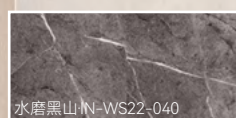

水磨黑山 IN-WS22-040

## 纯色 /SOLID COLOR

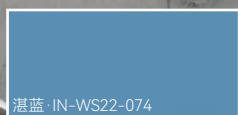

湛蓝 IN-WS22-074

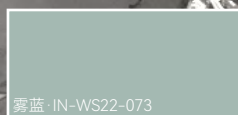

雾蓝 IN-WS22-073

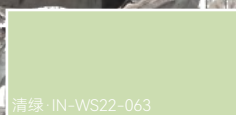

清绿 IN-WS22-063

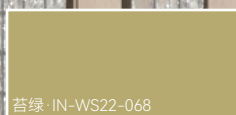

苔绿 IN-WS22-068

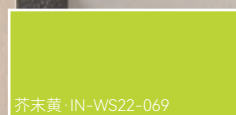

芥末黄 IN-WS22-069



蛋壳黄 IN-WS22-071

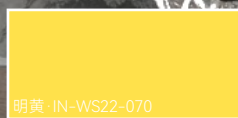

明黄 IN-WS22-070

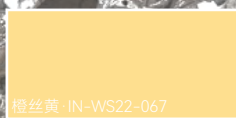

橙丝黄 IN-WS22-067

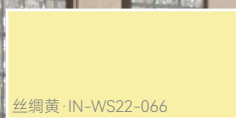

丝绸黄 IN-WS22-066

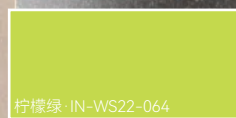

柠檬绿 IN-WS22-064

## 布艺 /CLOTH



碳色织 IN-TR22-001



米色织 IN-TR22-002

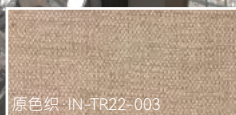

原色织 IN-TR22-003

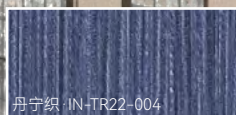

丹宁织 IN-TR22-004



木棉织 IN-TR22-005



亚麻织 IN-TR22-006

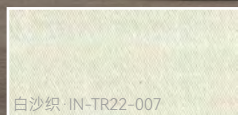

白沙织 IN-TR22-007



古诺深蓝 IN-PP22-066



布鲁诺织 IN-TR22-008



卢赛利雅灰 IN-PP22-071

\* 关注公众号，了解详情。请参照《2022 INSPACE 电子色卡集》



INSPACE 公众号

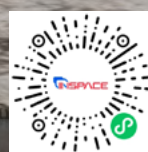

INSPACE 售后小程序

如您遇到任何售后和维护问题，请扫码进入小程序进行售后！

400 888 0198

[www.saint-gobain.com.cn/inspace](http://www.saint-gobain.com.cn/inspace)

上海市静安区山西北路 99 号苏河湾中心 15 楼 02B、03、04 单元  
成都市西岭路北蓝润摩里中心 2203 圣戈班速造



圣戈班订阅号



圣戈班服务号



INSPACE 公众号