



DUCTILE IRON PIPE SOLUTIONS

A SAFE PATH FOR WATER

Saint-Gobain PAM APAC

Address: Room 1808, 18th Floor, Building No.5, Zi Yun Wisdom Plaza, No. 19
Kazimen Avenue, Qinhuai District, Nanjing, PRC
Phone: +86 4008880198

www.pamline.com
<https://www.saint-gobain.com.cn/en/pam>



A SAFE PATH FOR WATER

PAM
SAINT-GOBAIN

CONTENTS

A SAFE PATH FOR WATER	1
CENTENNIAL INHERITANCE	3
INNOVATION	4
QUALITY FIRST	6
MANUFACTURING PROCESS	7
SUSTAINABLE DEVELOPMENT	9
PRODUCT RANGE AND STANDARDS	13
RAPID INSTALLATION	15
THE STANDARD JOINT	16
PRODUCTS AND APPLICATIONS	17
PROJECT REFERENCE	27

A SAFE PATH FOR WATER



PAM, originates from the pipe business of Saint-Gobain group of France, which is one of the world's top 500 companies.

PAM brand, founded in 1856, is a world-renowned ductile iron pipeline brand, committed to providing a complete set of suitable high-quality solutions for water supply and drainage pipeline system.



PAM produces pipes, fittings, valves, stainless steel pipes to multi-situations as:

- >>Municipal water supply and drainage pipeline, covering rainwater and sewage diversion and regeneration water pipeline, pipe gallery and other application scenarios;
- >>Long distances water diversion pipelines for Water sources, reservoirs, rivers and hydraulic hubs, and irrigation pipelines;
- >>Trenchless pipelines;
- >>Water supply and distribution pipelines for industrial park, new area, small hydropower and subway;
- >>Building water supply and drainage pipeline.

With the proprietary technology, high-quality products and high-level services, PAM enjoys a high reputation in the field of ductile iron pipeline system

100 << Providing pipes and fittings for more than 100 capitals and 10000 cities

50000 << Over 50000 project references

160 << Over 160-years' experience on pipe manufacturing and application

1500 << More than 1500 patents

In 1997, PAM sent an experienced management team and technical experts from France to China to take charge of the construction, operation and technical guidance of PAM China. The process requirements and quality standards of PAM China are consistent with those of European factories. Thanks to PAM's experience over 160 years in casting pipe production, PAM China has a more advanced ductile iron pipeline production line in the world, which allows us to provide high-quality products and services to win the high recognition of customers.

CENTENNIAL INHERITANCE

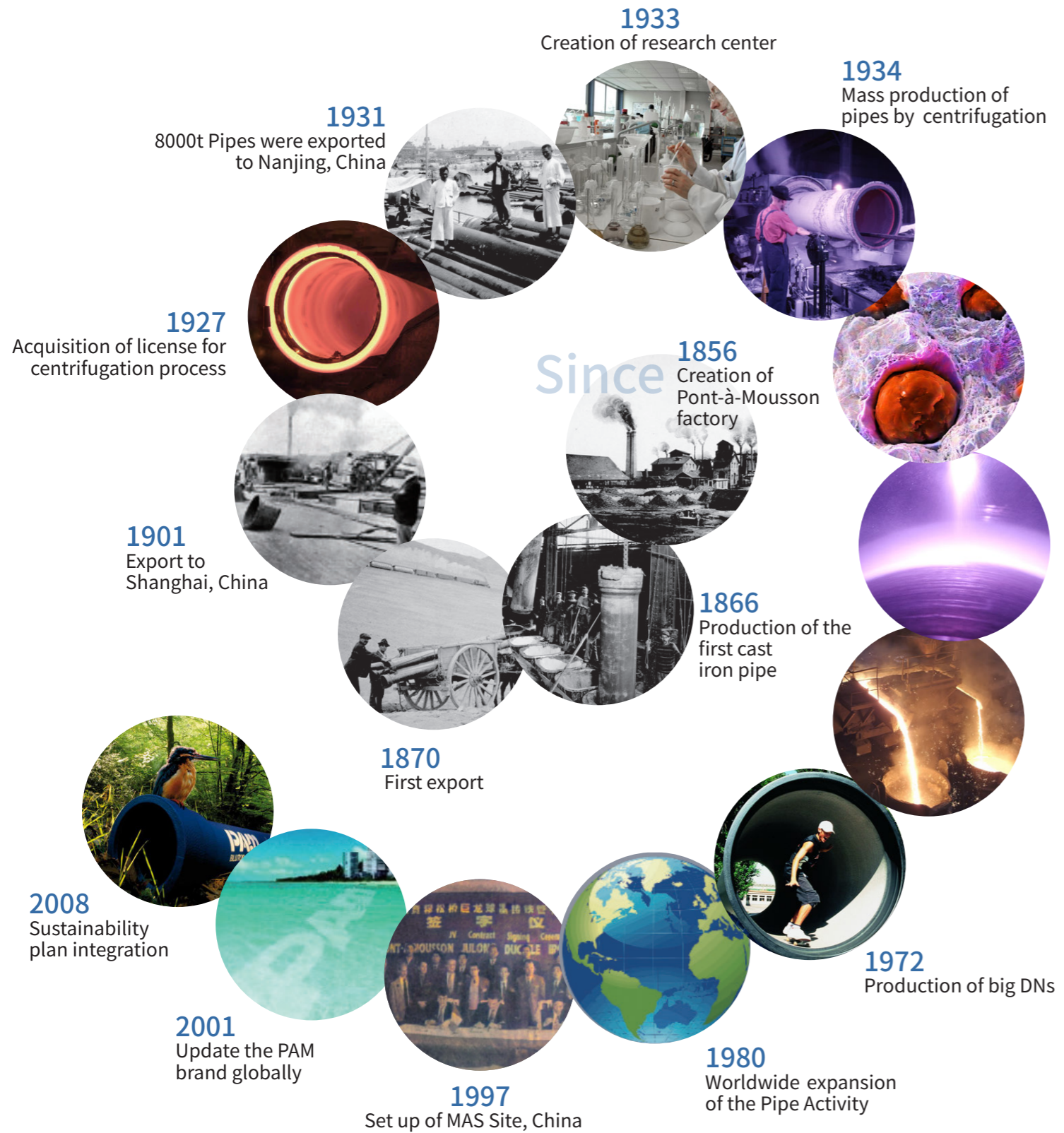

INNOVATION



Innovation has always been the key advantage of PAM to provide excellent products and strong market competitiveness.



INNOVATION

1980
ZMU pipes



1980
PUX



1992
PE External Lining



1994
Integral Pipe



1998
PUR



2002
TAG



2002
C class pipe



2006
ZnAl coating



2020
Water-based coating

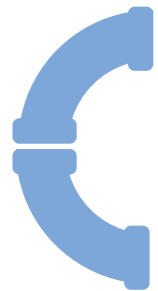

PAM is endowed with ingenuity. For more than 160 years, we continuously improve the manufacturing process, accelerate the iteration of products, with the advanced R&D team. Since 1980, various new products have been launched which adapted to new market demands.

QUALITY FIRST

Quality is the responsibility of everyone in PAM. In order to provide excellent products and services, our quality objective is to carry out all work with customers. It is also the quality culture that we have formed and implemented by all staff in the long-term company operation, so as to realize that the PAM brand has become a model of quality during the entire life cycle of our products.

In terms of products and services provided to customers, our goal is zero complaints. This goal is achieved through the following measures:

- >> Strictly implement the quality-closing policy
- >> Excellent production technology
- >> Eliminate quality failure cost
- >> Implement high quality standards for all products, including purchased parts
- >> Rapid response to customer demands

This goal will be achieved through an effective and efficient quality management system. In every field of our business, the system is also continuously improving.

MANUFACTURING PROCESS

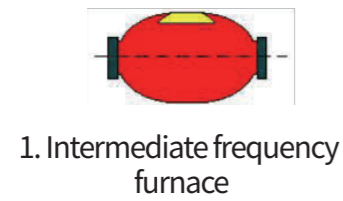

1. Intermediate frequency furnace

Molten iron refining

- All raw materials are tested in all aspects
- Monitoring the chemical composition of molten iron in each set
- Monitoring the temperature of molten iron in each set before outlet
- Monitoring data are all networked and shared online

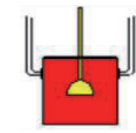

2. Spheroidizing treatment

Spheroidizing treatment

- Monitoring the chemical composition of each ladle
- Measure the temperature of each ladle of molten iron before casting

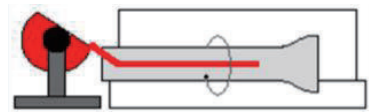

3. Centrifuge

Centrifugation casting

- The highest production efficiency in the world
- The pioneered automatic pipe extracting technology in China.

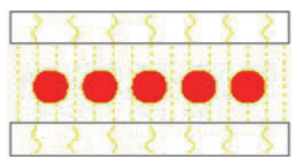

4. Heat treatment

Heat treatment

- Intelligent temperature control
- Monitoring metallographic structure and mechanical properties

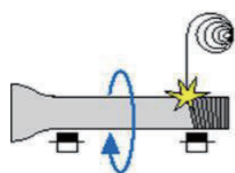

5. Zinc Spraying

Zinc Spraying

- Strict control of zinc spraying amount
- The pioneered anti-corrosion of zinc-aluminum alloy in China

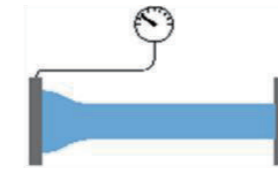
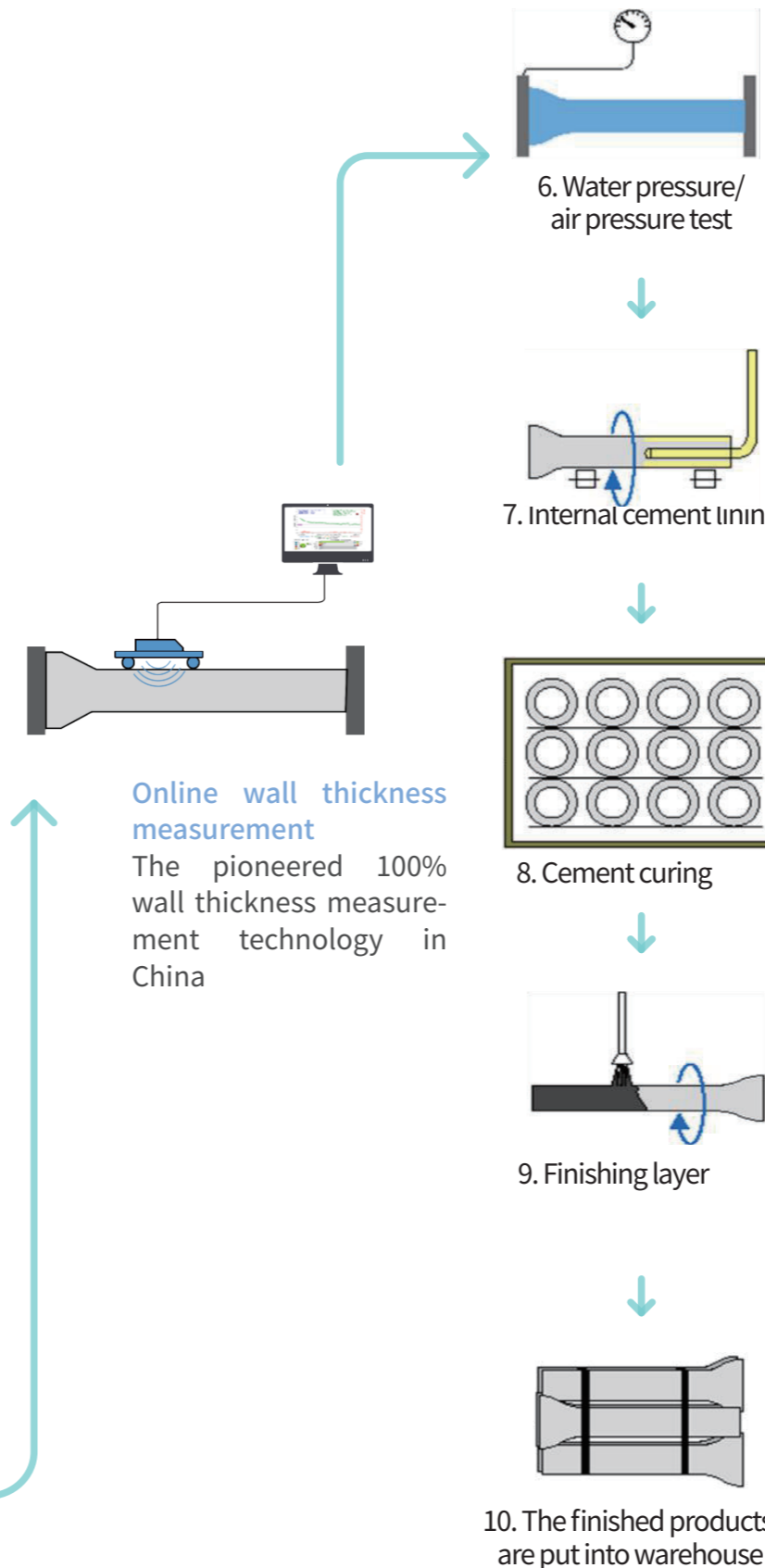

6. Water pressure/air pressure test

Water pressure/air pressure test

- 100% water pressure test
- The pioneered air pressure test in pipes with small diameters



7. Internal cement lining

Internal cement lining

- Adopt blast furnace slag cement, which is the pioneered BFSC in China
- Monitoring the quality of raw materials, appearance of internal lining, wall thickness and performance.

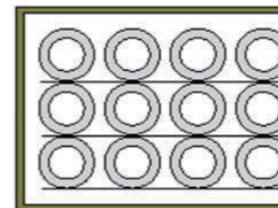

8. Cement curing

Cement curing

- Curing through blast furnace steam
- Intelligent temperature and humidity monitoring

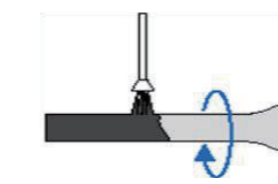

9. Finishing layer

Finishing layer

- Equipped with preheating and drying process.
- Intelligent temperature and humidity monitoring
- Adopt water-based coating to realize zero VOC emission.

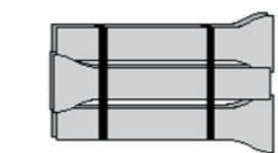

10. The finished products are put into warehouse

The finished products are put into warehouse

- Using WMS for warehouse management

SUSTAINABLE DEVELOPMENT HAS ALWAYS BEEN A CENTRAL POLICY OF SAINT GOBAIN PAM, FROM-PRODUCT DESIGN TO DELIVERY.

Water is the important natural resources for human survival and development. In order to strengthen the sustainable and effective use of water, the safety and low leakage rate of the pipelines attract more attention. As a global excellent ductile iron pipeline service provider, PAM has guaranteed that the company will continue to provide high quality, high resistance, safe and reliable water distribution pipeline solutions, through customer-oriented research strategy.

The commitment of PAM: reduce energy consumption on all phases of operation, manufacturing and transportation.

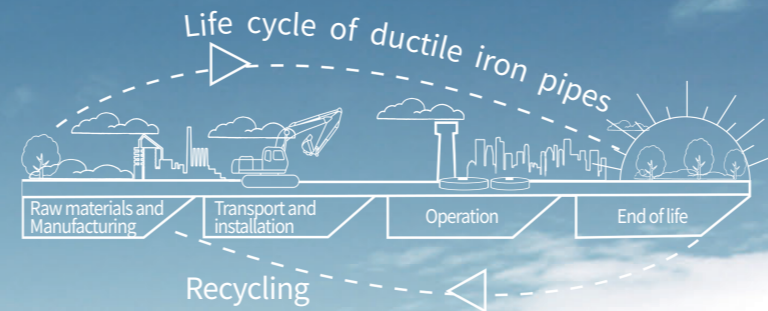

100% Recyclable Material
 Ductile iron pipelines, the majority of which are produced by recycling materials, are also 100% recyclable, without any loss of its mechanical properties. Both old cast iron pipelines and ductile iron are chemically inert, non-toxic and easily recyclable through the local scrap industry.

Energy Saving & Environmental protection
 PAM has world-class automatic production process and control technology, which greatly reduces CO₂ emissions in the production process.

Smart & Low Carbon Logistics
 Complying with the purpose of low-carbon transportation, PAM is using diversified and low energy consumption transportation schemes.

Customized Field Application
 In order to adapt to different application conditions, PAM can provide a full range of solutions, such as providing high anti-corrosion coatings and scientific joint methods to extend the lifespan of the pipe network and reduce leakage and providing patented coating to ensure water quality safety.

QUALITY CERTIFICATIONS

- >> The company has passed ISO9001 Quality Management System Certification since its establishment;
- >> Since 2012, the company has won the Golden Cup of High-quality Products of China Iron and Steel Industry Association. And In 2015, the company won the only Excellent Quality Award in the industry.
- >> Since 2015, the company passed the Laboratory Accreditation Certificate issued by CNAS
- >> In 2020, the company passed ISO 10012: 2003 & GB/T 19022: 2003 Measurement Management System Certification and won the highest AAA level.
- >> And many other international certifications

- ✓ BV
- ✓ AS/NZS 2280
- ✓ ICONTEC
- ✓ Kitemark
- ✓ WRAS
- ✓ CERTIMEX
- ✓ GSK
- ✓ ACCREDIA
- ✓ DVGW



WCM (world-class manufacturing), a journey towards excellent operation and customer satisfaction

In 2021, PAM China won the WCM bronze certification of Saint-Gobain Group, and it is also the first factory in Saint-Gobain Asia Pacific region to win this honor, which is the best affirmation of the excellent operation of PAM China.

SUSTAINABLE DEVELOPMENT



THE ENVIRONMENTAL VALUES

THE ECOLOGICAL FOOTPRINT IN A COMPLETELY TRANSPARENT MANNER

The PAM LCA calculator software package is designed to assess the environmental footprint. It analyses the life cycle (LCA) from the manufacturing, transport, installation, operation until recycling. Complying with the EN 14044 standard, this software package enables to assess on a defined project:

- Emissions of greenhouse gases (CO₂, equivalent)
- Consumption of fossil fuel (M joule)
- The volume of water taken from nature (m³)

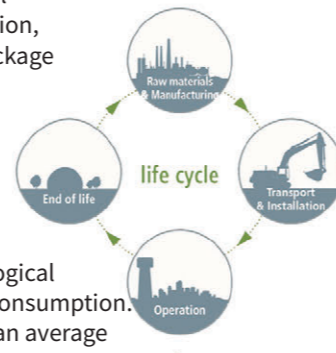

ALL PAM factories produce under ISO 14001 control, in order to minimise the ecological impacts, to prevent pollution incidents, to control waste management and water consumption. Thanks to new industrial processes, PAM has reduced its energy requirements by an average of 30% to manufacture a pipe of the same diameter.

100% RECYCLABLE AND INDEFINITELY

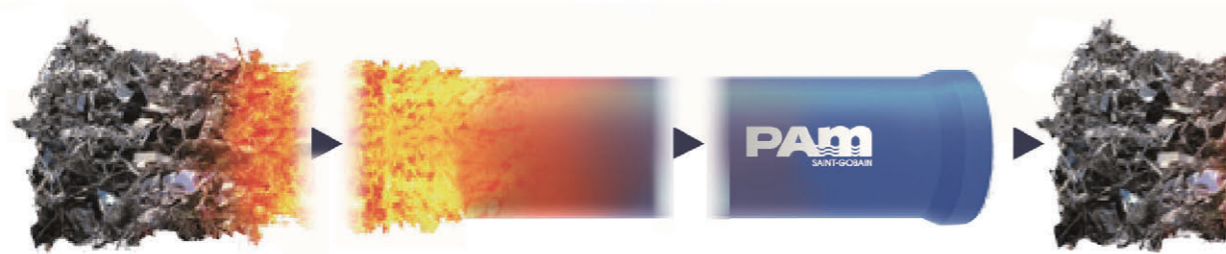

The re-use of recycled scrap recovered from iron and steel manufacture is considered inexhaustible. Ductile cast iron, derived largely from scrap, is 100% recyclable and easily, due to the proximity of metal recycles.

PRESERVED NATURAL SOIL

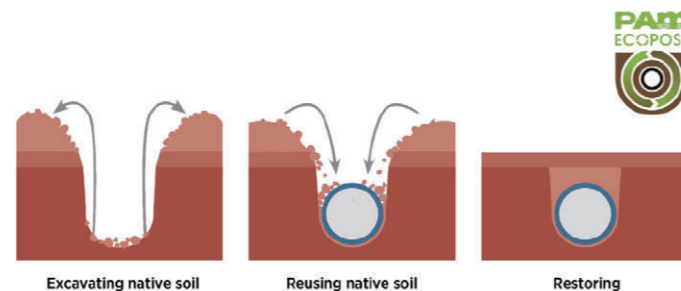

Cast iron pipelines are rigid and robust and do not require excessive-compaction rates when they are laid in trenches. **They enable to reuse native backfills rather than materials imported from distant quarries.** This good practice participates in the preservation of soil in its natural state while reducing costs and the site's ecological footprint.

TCO-LCA ASSESSMENT

Hypotheses of calculations performed with LCA-TCO PAM calculator:

- For **HYDROCLASS**® pipes DN 200
- Laid in trenches under standard conditions
- Transported over 13000 km by ship
- Technico-economic data of the year 2014 for Asia/Middle East areas
- Service life 100 years

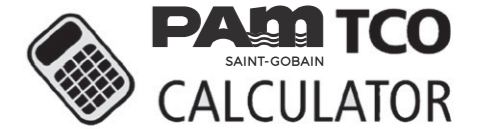

The values below, based on hypothetical cases and average date, are proposed for information. They are not contractual in nature.

TCO ANALYSIS (TOTAL COST OF OWNERSHIP)

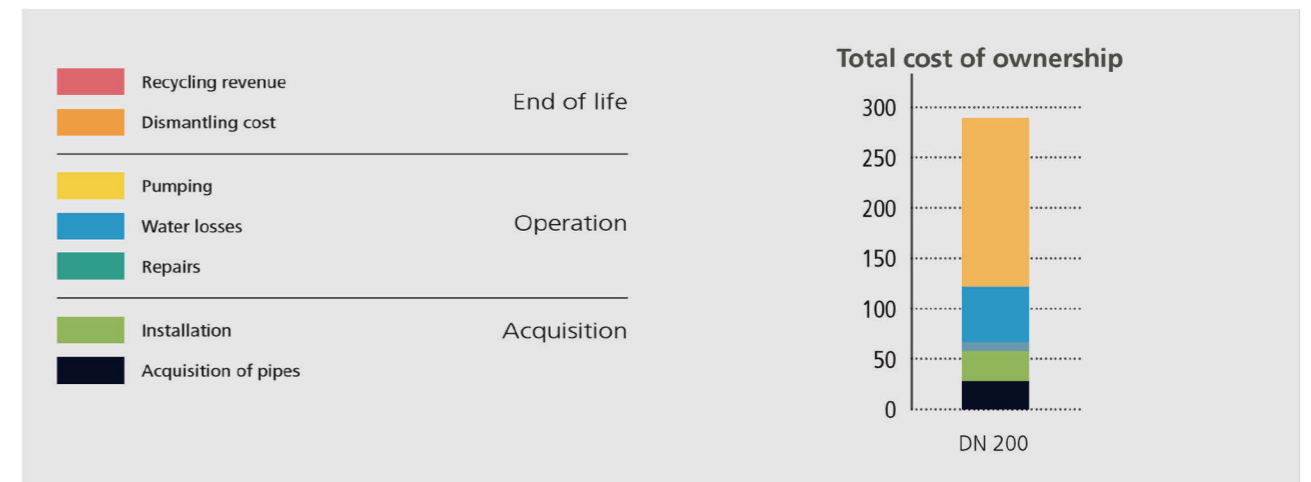

LCA ANALYSIS (LIFE CYCLE)

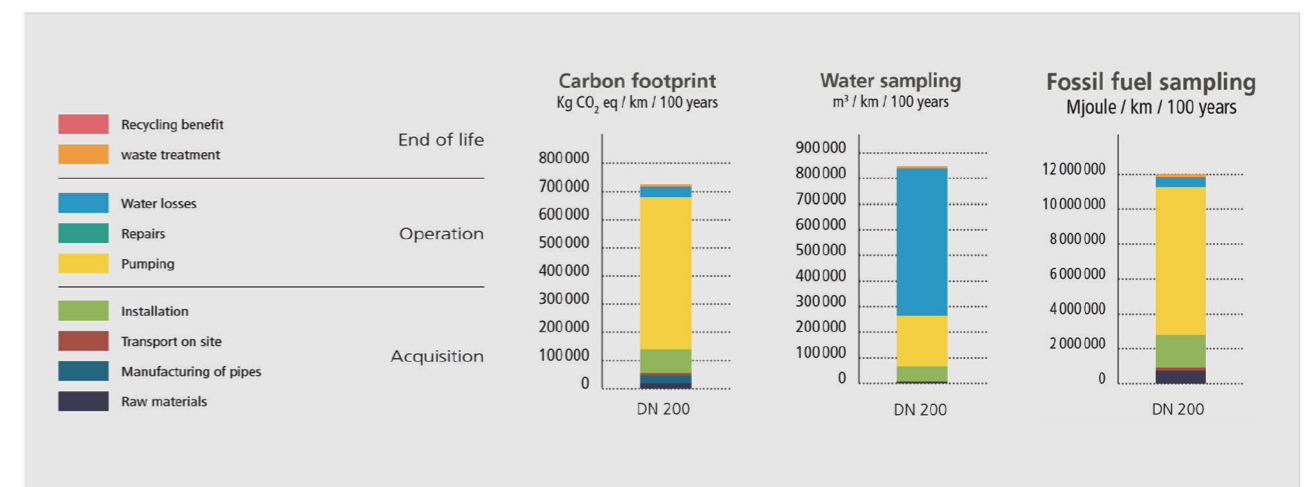

PRODUCT RANGE AND STANDARDS

COMPLETE RANGE OF ANCHORED OR NON-ANCHORED JOINTS FOR PIPE

DN80	DN100-250	DN300-600	DN700-1000	DN1200-1400	DN1400-2000
------	-----------	-----------	------------	-------------	-------------

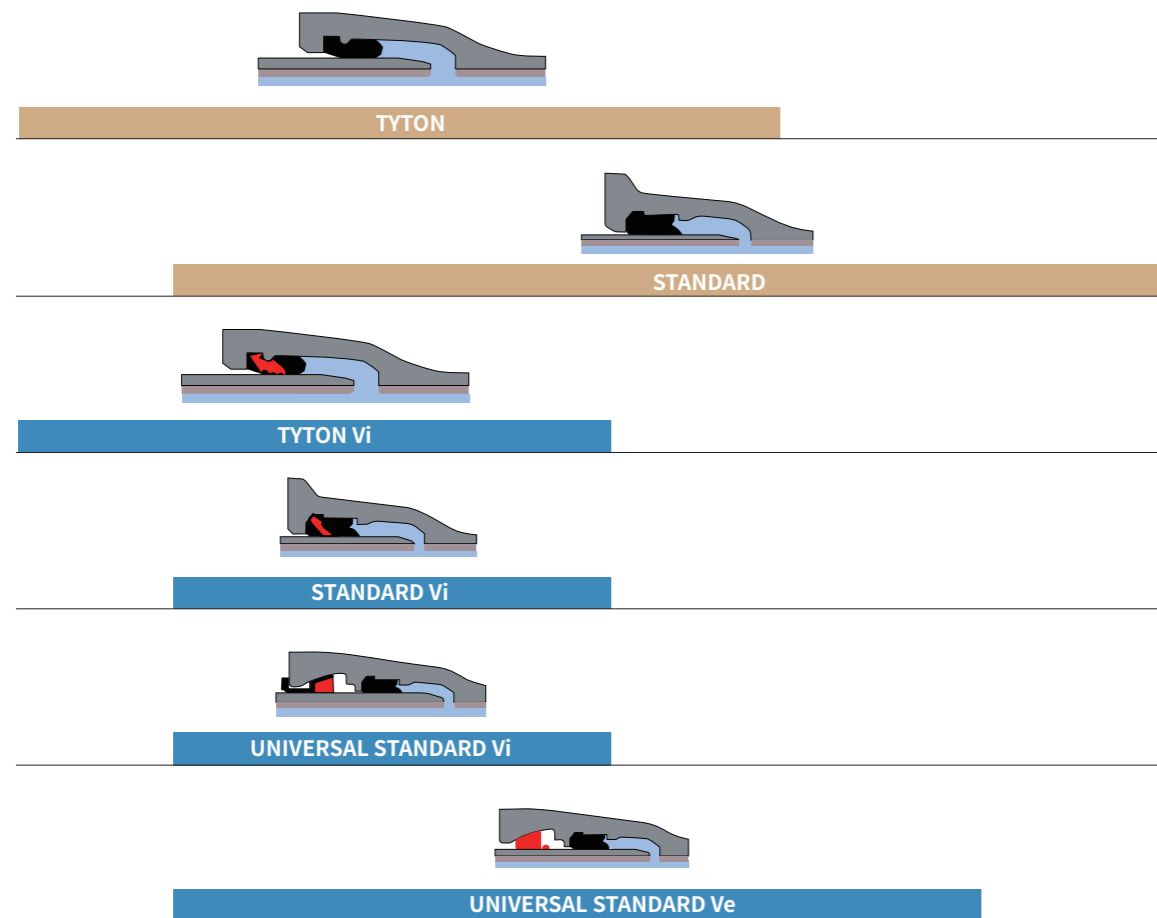

Anchored Joint	Theory	Advantages
Uni. STD Ve	Uni. STD joint pipe with weld bead + locking ring	<ul style="list-style-type: none"> • Large deflection angle and great self-anchor ability • High durability • Safety
Self-Anchored Gasket	The anchored gasket contains embedded stainless steel teeth	<ul style="list-style-type: none"> • More economical installation • Allows a certain angle of deflection

PARAMETER OF UNI. STD VE DN100-DN1200

Diameter	Joint	PFA bar	Max deflection angle	wall thickness e mm	Socket diameter mm	Length m
DN100	C100	85	3	6.0	188	5.97
DN150	C64 class Uni. STD Ve	63	3	6.2	230	5.97
DN200		52	3	6.5	290	5.97
DN300	C class* Uni. STD Ve	41	3	7.4	408	5.97
DN350		38	3	7.7	463	5.97
DN400		35	3	8.1	510	5.97
DN450		32	3	8.6	570	5.97
DN500		30	2	9.3	625	5.97
DN600		30	2	10.9	740	5.97
DN700	Uni. STD Ve	27	2	10.8	855	5.93
DN800		25	2	11.7	980	5.93
DN1000		25	1.2	13.5	1191	5.92
DN1200		25	1.1	15.8	1415	5.97

*one level upgrade than preferred C class

C CLASSES (PRESSURE CLASSES)

>> Preferred pressure classes

>> Or Additional pressure classes for specific requirements

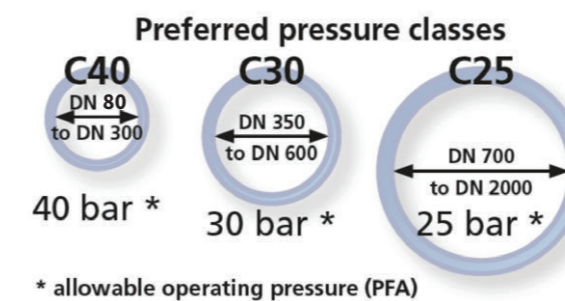

K THICKNESS CLASSES (K9, ETC.)

>> DUCTILE IRON PIPE AND FITTING STANDARDS:

	ISO Standard	EN Standard	GB/T Standard	AS Standard
Ductile iron products for water application	ISO 2531	EN 545	GB/T 13295	AS/NZS 2280
Ductile iron products for sewerage applications	ISO 7186	EN 598	GB/T 26081	AS/NZS 2280

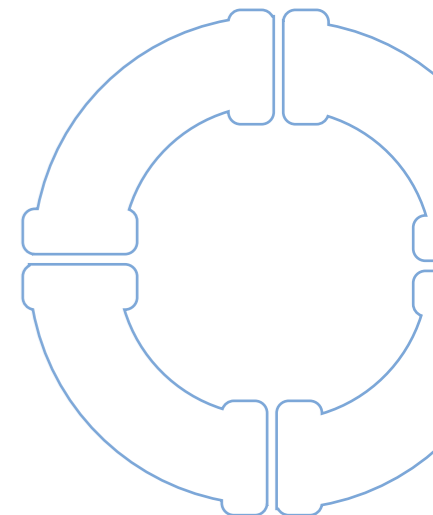

RAPID INSTALLATION

ROBUST COMPONENTS

PAM designs efficient and robust parts, compatible with conditions of transportation by truck, train, ship, capable of withstanding stacking up of stocks and rough handling on sites.

HIGH INSTALLATION RATES

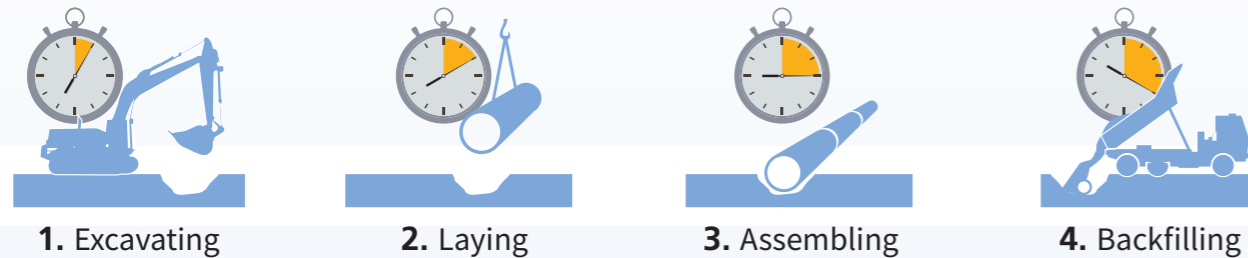

Laying, aligning, fitting! No welding on site, no repairing of the coating, no ultrasonic or X-ray examination... no other material can match the assembly rate of cast iron pipes with sockets. No immobilisation of specialised equipment, or waiting time for drying or cooling of

assemblies. Nothing equals the management flexibility of shut-downs, restarting and progress of the site with PAM technology.



▶▶ BE A PAM PRO

ANY TIME, ALL TERRAINS

Deserts or forests, swamps or mountains, sunshine or snow; the products, their protection and their assembly are designed for all climates and all situations. An excavator for straight lines at high rate, simple hand winches at the bottom of inaccessible trenches! No

waiting time, irrespective of the temperature and humidity level. The short pipe lengths (6m and 8m) facilitate access with equipment of standard size and favourably limit the site's right-of-way strip.



THE STANDARD JOINT

The STANDARD joint has been the preferred assembly system of pipeline contractors for 60 years.

QUICK AND SELF-SEALING

The watertightness of the STANDARD joint results from the radial compression of the sealing ring (1), by the simple introduction of the spigot ends into the socket. It does not depend on the tightening torque of bolts, or a welding process. The STANDARD joint is perfectly suitable for installation conditions in trenches or overhead, irrespective of weather conditions.

TESTED UNDER PRESSURE AND NEGATIVE PRESSURE

All PAM joints are qualified under extreme conditions required by the EN 545 standard (pressure, negative pressure, fatigue and water logging from the outside).

WITHOUT WELDING, OR REWORKING

No welding on site, no repair of coatings. As an example, 8 minutes are sufficient to create a watertight junction at 25 bars on a ductile cast iron pipe of DN 1000!

FLEXIBLE

The angular deviation and axial displacement capacity gives the pipeline a chain like behaviour in unstable ground, or simply correct the actual route depending on obstacles encountered.

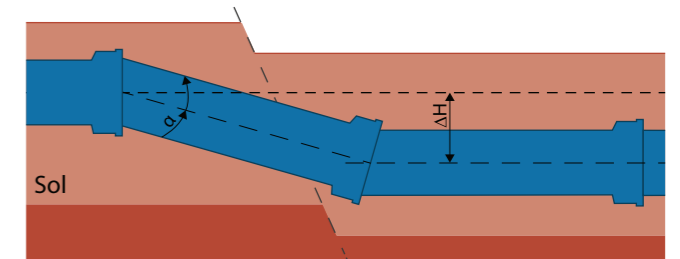
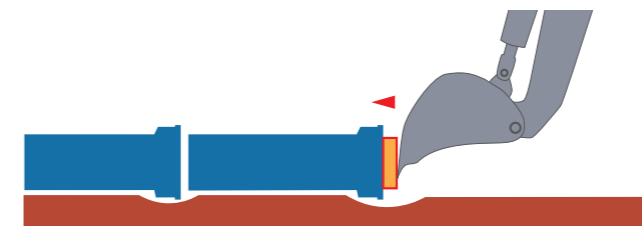

PAM TECHNOLOGY

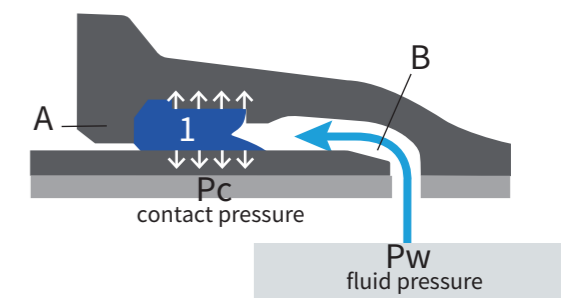

The STANDARD joint is self-sealing: the greater the water pressure (P_w), the greater the contact pressure (P_c) between the elastomer ring and the metal. This property is obtained thanks to the shape of the sealing ring (1) and to the physical characteristics of the elastomer. The heel (A) of the socket prevents the expulsion of the joint, and the cavity (B) authorises the angular deviation, even at high pressure. The sealing ring is an EPDM elastomer. Rigorously selected, it guarantees the maintenance of its physico-chemical characteristics over a very long duration.

PRODUCTS AND APPLICATIONS

POTABLE WATER

PAM C CLASS DUCTILE IRON PIPES

C Class Ductile iron pipes, its performance parameters are strictly in accordance with ISO2531 and EN545. C class pipe represents the technological progress and development of ductile iron pipe industry.

- >> DN Range: DN100-DN2200mm
- >> Joint: T-type / STD-type
- >> Internal Lining: ISO 4179
 - Cement Mortar Lining (BFSC, SRC)
 - Cement Mortar Lining+ Seal Coating
- >> External Coating: ISO 8179
 - Zinc (130g/m² or 200g/m²) + finishing layer not less than 70/100µm
 - ZnAl (400g/m²) + finishing layer not less than 70/100µm
- >> Unit Length: 6m / 5.75m / 5.5m

C class ductile iron pipe is environmentally friendly and focuses on customer requirements, this product conforms with the sustainable development strategy.

TECHNICAL PARAMETERS

DN100-DN2200

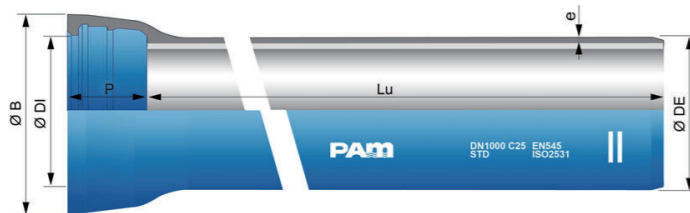

DN mm	Lu m	Preferred Class	e mm	DE mm	PFA bar
100	6	C40	4.4	118	40
150	6	C40	4.5	170	40
200	6	C40	4.7	222	40
250	6	C40	5.5	274	40
300	6	C40	6.2	326	40
350	6	C30	6.3	378	30
400	6	C30	6.5	429	30
450	6	C30	6.9	480	30
500	6	C30	7.5	532	30
600	6	C30	8.7	635	30
700	6	C25	8.8	738	25
800	6	C25	9.6	842	25
900	6	C25	10.6	945	25
1000	6	C25	11.6	1048	25
1100	6	C25	12.6	1152	25
1200	6	C25	13.6	1255	25
1400	6	C25	15.7	1462	25
1500	6	C25	16.7	1565	25
1600	6	C25	17.7	1668	25
1800	6	C25	19.7	1875	25
2000	6	C25	21.8	2082	25
2200	6	C25	23.8	2288	25

FIELD OF USE :

For drinking water and other water network applications (except sewage water)

POTABLE WATER

PAM K9 CLASS DUCTILE IRON PIPES

K9 Class Ductile Iron pipes, produced by centrifugal casting process, in accordance with ISO2531, EN545, GB/T 13295.

- >> DN Range: DN80-DN2200mm
- >> Joint: T-type / STD-type
- >> Internal Lining: ISO 4179
 - Cement Mortar Lining (BFSC, SRC)
 - Cement Mortar Lining+ Seal Coating
- >> External Coating: ISO 8179
 - Zinc (130g/m² or 200g/m²) + finishing layer not less than 70/100µm
 - ZnAl (400g/m²) + finishing layer not less than 70/100µm
- >> Unit Length: 6m / 5.75m / 5.5m

TECHNICAL PARAMETERS

DN80-DN2200

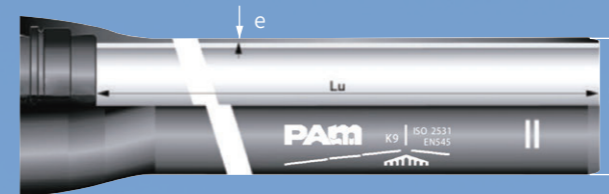

DN mm	Lu m	Class	e mm	DE mm	PFA bar
80	6	K12	6.96	98	168
100	6	K9	6	118	64
150	6	K9	6	170	64
200	6	K9	6.3	222	62
250	6	K9	6.8	274	54
300	6	K9	7.2	326	49
350	6	K9	7.7	378	45
400	6	K9	8.1	429	42
450	6	K9	8.6	480	40
500	6	K9	9	532	38
600	6	K9	9.9	635	36
700	6	K9	10.8	738	34
800	6	K9	11.7	842	32
900	6	K9	12.6	945	31
1000	6	K9	13.5	1048	30
1100	6	K9	14.4	1152	29
1200	6	K9	15.3	1255	28
1400	6	K9	17.1	1462	27
1500	6	K9	18.0	1565	27
1600	6	K9	18.9	1668	27
1800	6	K9	20.7	1875	26
2000	6	K9	22.5	2082	26
2200	6	K9	24.3	2288	25

FIELD OF USE :

For drinking water and other water network applications (except sewage water)

PRODUCTS AND APPLICATIONS

SEWAGE WATER

PAM SEWAGE DUCTILE IRON PIPES

SEWAGE Ductile Iron pipes in accordance with EN598, ISO7186, GB/T 26081.

>> DN Range: DN80-DN2200mm

>> Joint: T-type / STD-type

>> Internal Lining: High-Alumina cement (HAC) ISO 4179

>> External Coating: ISO 8179

DN80-DN1000 Zinc (130g/m² or 200g/m²)+Red finishing layer not less than 80µm

DN1100-DN2200 Zinc (200g/m²)+ Red finishing layer not less than 80µm

DN80-DN2200 ZnAl 400g/m²+ Red finishing layer not less than 80µm

>> Unit Length: 6m/ 5.75m/ 5.5m

EXCELLENT HIGH-ALUMINA CEMENT

>> SEWAGE Ductile Iron pipes focus on multiple erosion in terms of corrosion risks. The high-alumina cement contains with over 50% alumina, which has excellent anti-corrosion and wear resistance properties and can normally transport domestic sewage at pH 4 to 12.

>> The high-alumina cement is laid by centrifugal method.

NBR GASKET

Due to the direct contact with sewage, the gasket must be able to resist the corrosion of a variety of chemicals, not only the strong corrosion of sewage in lower acidity, but also must be able to prevent other chemicals and grease, PAM provides high quality NBR gaskets to meet these requirements.

TECHNICAL PARAMETERS

DN80-DN2200

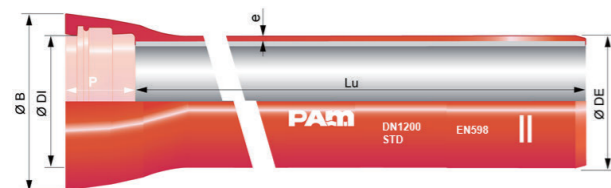

FIELD OF USE :

Separate sewer system and combined sewer system Application:

- >> gravity flow and rising main sewerage systems
- >> Type of effluent: domestic wastewater and rainwater
- >> Perfectly watertight
- >> For effluents between pH4 and pH12
- >> For the soils with 6 < pH < 9
- >> Majority of the soils, except the acid peaty and polluted soils

DN mm	Lu m	EN598		PFA bar
		e mm	DE mm	
80	6	4.8	98	40
100	6	4.8	118	40
150	6	4.8	170	40
200	6	4.9	222	40
250	6	5.3	274	38
300	6	5.6	326	35
350	6	6.0	378	32
400	6	6.3	429	30
450	6	6.7	480	29
500	6	7.0	532	28
600	6	7.7	635	26
700	6	9.6	738	29
800	6	10.4	842	28
900	6	11.2	945	27
1000	6	12.0	1048	26
1200	6	15.3	1255	29
1400	6	17.1	1462	28
1500	6	17.9	1565	27
1600	6	18.9	1668	27
1800	6	20.7	1875	27
2000	6	22.5	2082	26
2200	6	24.3	2288	25

*Please consult us for ISO7186 or GB/T 26081 pipe.



SPECIAL PRODUCT FOR HONG KONG MARKET

POTABLE WATER

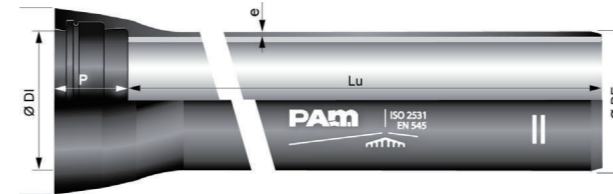

DN mm	Lu m	C Class	e mm	DE mm	DI mm	P mm
80	5.5 or 6.0	100	7.0	98	100.5	85
100	5.5 or 6.0	100	7.2	118	120.5	88
150	5.5 or 6.0	100	7.8	170	172.5	94
200	5.5 or 6.0	64	8.4	222	224.5	100
250	5.5 or 6.0	64	9.0	274	276.5	105
300	5.5 or 6.0	64	9.6	326	328.5	110
350	5.5 or 6.0	64	10.2	378	380.9	110
400	5.5 or 6.0	50	10.8	429	431.5	110
450	5.5 or 6.0	50	11.4	480	482.5	120
500	5.5 or 6.0	50	12.0	532	534.5	120
600	5.5 or 6.0	50	13.2	635	637.5	120

*Nominal wall thickness e is Class K12

FIELD OF USE :

>> For drinking water networks

Main characteristics :

- >> External coating : metallic zinc (200g/m²) + bituminous or synthetic paint
- >> Internal lining : sulfate resisting blast furnace cement mortar
- >> EN 545

SEWAGE

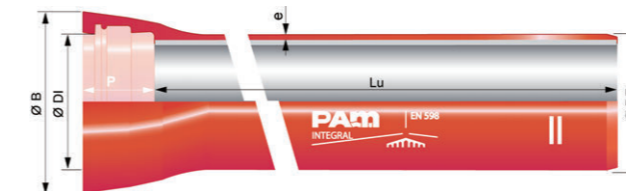

DN mm	Lu m	Class	e mm	DE mm	DI mm	P mm	B mm	PFA bar
80	5.5	K12	7.0	98	100.5	85	140	85
100	5.5	K12	7.2	118	120.5	88	163	85
150	5.5	K12	7.8	170	172.5	94	217	85
200	5.5	K12	8.4	222	224.5	100	278	85
250	5.5	K12	9.0	274	276.5	105	336	78
300	5.5	K12	9.6	326	328.5	110	393	70
350	5.5	K12	10.2	378	380.9	110	448	64
400	5.5	K12	10.8	429	431.5	110	500	60
450	5.5	K12	11.4	480	482.5	120	540	57
500	5.5	K12	12.0	532	534.5	120	604	54
600	5.5	K12	13.2	635	637.5	120	713	50

FIELD OF USE :

- >> For under pressure networks (not convenient with septic conditions – with presence of hydrogen sulfide, H₂S, please consult us)
- >> Domestic waste waters
- >> Storm Water (Rain Water)
- >> Perfectly watertight
- >> For effluents between pH4 and pH12
- >> For the soils with 6 < pH < 9
- >> Majority of the soils, except the acid peaty and polluted soils

Main characteristics :

- >> External coating: metallic zinc (130g/m² or 200g/m²) + red paint
- >> Internal coating: High Alumina cement mortar
- >> EN598 and ISO7186

PRODUCTS AND APPLICATIONS



AS/NZS PAM PIPE WITH AS TYT JOINT

SPECIFICATION

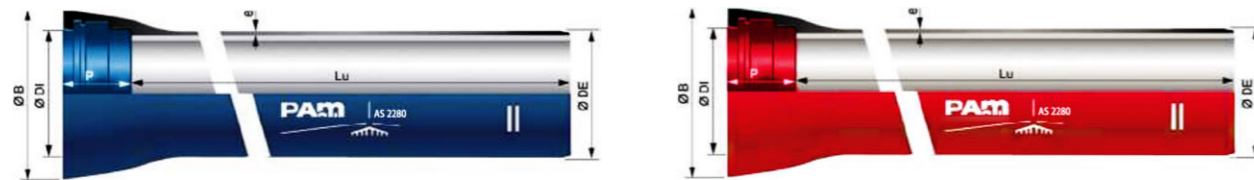

DN100-750

DN mm	Lu m	PN	e mm	DE mm	DI mm	P mm	B mm
100	5.75	PN35	4.9	122	124.7	89	162.7
150	5.75	PN35	5.0	177	179.7	89	218.3
200	5.75	PN35	5.0	232	235.2	102	278.2
225	5.75	PN35	5.0	259	262.1	102	303.4
250	5.75	PN35	5.2	286	289.0	102	329.5
300	5.75	PN35	5.9	345	348.2	102	391.4
375	5.75	PN35	7.0	426	430.5	127	487.3
450	5.75	PN35	8.1	507	511.2	127	570.7
500	5.75	PN35	8.8	560	564.3	127	626.0
600	5.75	PN35	10.2	667	671.2	135	751.4
750	5.75	PN35	12.3	826	830.2	157	912.7

DN mm	Lu m	PN	e mm	DE mm	DI mm	P mm	B mm
225	5.75	PN20	4.5	259	262.1	102	303.4
250	5.75	PN20	4.6	286	289.0	102	329.5
300	5.75	PN20	4.6	345	348.2	102	391.4
375	5.75	PN20	4.8	426	430.5	127	487.3
450	5.75	PN20	5.4	507	511.2	127	570.7
500	5.75	PN20	5.8	560	564.3	127	626.0
600	5.75	PN20	6.7	667	671.2	135	751.4
750	5.75	PN20	8.0	826	830.2	157	912.7

Note: Dimensions are given as nominal value | Higher pressure is available for Flange Class

LEGEND

DN: nominal diameter	e: nominal thickness to AS/NZS 2280:2020, in mm
Lu: laying length, in m	DE: external nominal diameter of the barrel to AS/NZS 2280:2020, in mm
PN: pressure rating to AS/NZS 2280:2020	DI: internal nominal diameter of the socket, in mm
P: nominal depth of the socket, in mm	B: nominal external diameter of the socket, in mm

HYDROCLASS® ZINALIUM®

FIELD OF USE :

>> For drinking water networks and other water networks

MAIN CHARACTERISTICS:

- >> AS TYT joint in EPDM to AS1646
- >> External coating:
 - ZINALIUM® alloy Zn85Al15 (400 g/m²)
 - Blue cobalt synthetic pore sealer minimum 100 microns to AS3750.19
- >> Internal coating:
 - Blast Furnace Slag Cement mortar (BFSC) to AS3972 type GB
 - Option: seal coated to ISO 16132
- >> In conformance to AS/NZS 2280:2020
- >> Water contact areas tested to AS/NZS 4020

>> Details:

HYDROCLASS ZINALIUM®	
Available Diameter Range	DN100, 150, 200, 225, 250, 300, 375, 450, 500, 600, 750
Pressure Rating	PN20 - Green mark on socket face PN35 - Red mark on socket face Flange Class - Blue mark on socket face
Joints	Automatic push on TYT type rubber ring joint - DN100 to 750
Anchoring System	TYT push-on restraint joint - DN100 to 375
Deflection	DN100-250: 3.5° DN300-600: 2.5° DN750: 1°
External coating	ZINALIUM® 85/15 + 100µm blue synthetic coating
Coating option	HI MAYA® <ul style="list-style-type: none"> · Soils with a resistivity lower than 500 Ω.cm · Peaty and acid soils · Soils containing acidic industrial effluents, ashes or slag
Internal coating	Blast Furnace Cement Mortar (BFSC)
Length	DN100 to DN750: L=5.75m

INTEGRAL® ZINALIUM®

FIELD OF USE :

- >> For gravity sewer and pressure or pumped sewer networks
- >> Domestic waste water
- >> Very hard raw water and irrigation
- >> For effluents between pH4 and pH12

MAIN CHARACTERISTICS:

- >> AS TYT type joint in NBR to AS1646
- >> External coating:
 - ZINALIUM® alloy Zn85Al15 (400 g/m²)
 - Red synthetic pore sealer minimum 80 microns to AS3750.19
- >> Internal coating:
 - High Alumina Cement (HAC) to AS3972 type GB
- >> In conformance to AS/NZS 2280:2020

>> Details:

HYDROCLASS ZINALIUM®	
Available Diameter Range	DN100, 150, 200, 225, 250, 300, 375, 450, 500, 600, 750
Pressure Rating	PN20 - Green mark on socket face PN35 - Red mark on socket face Flange Class - Blue mark on socket face
Joints	Automatic push on TYT type rubber ring joint - DN100 to 750
Anchoring System	TYT push-on restraint joint available - DN100 to 375
Deflection	DN100-250: 3.5° DN300-600: 2.5° DN750: 1°
External coating	The external & socket area is coated with a red synthetic coating
Internal coating	High Alumina Cement (HAC)
Length	DN100 to DN750: L=5.75m

PRODUCTS AND APPLICATIONS

PAM TRENCHLESS SOLUTIONS-HDD

PAM provides trenchless pipe solution on Horizontal directional drilling area, which has advantages in safety and construction efficiency. PAM has been producing and selling ductile iron pipe systems with trenchless solution since early 1990s. For now, we can provide HDD pipe solution from DN100-1000.

Uni. STD Ve

- >> Structure: Special external ZMU cement, Joint protection with elastomer sleeve and HDD metal cone
- >> DN Range: DN100-DN1000mm
- >> Joint: Uni. STD Ve
- >> External Coating: Zinc (200g/m²)
- >> Unit Length: 5.97m

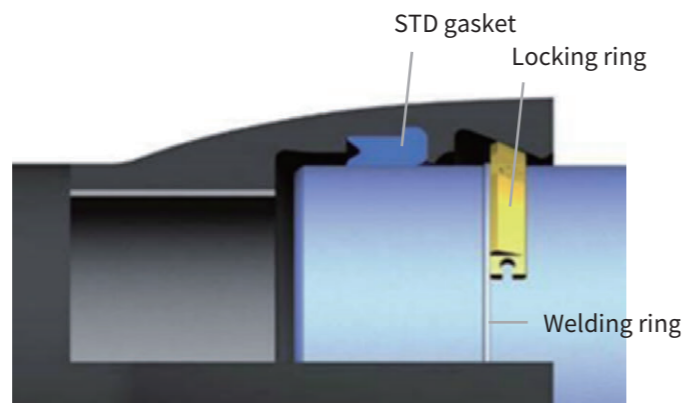

Uni. STD Ve + ZMU cement

- >> A lower layer is a 200g/m² Zn protection in compliance with EN545 applied by spraying on the ductile iron pipe.
- >> An adhesion primer between the 200g/m² Zn layer and the cement to ensure cement adhesion until installation.
- >> A cement mortar with reinforcing fibers for mechanical strength.
- >> Ductile iron pipes with ZMU by PAM coating are suitable:
 - In rocky soils with a backfill particles size up to 100mm
 - In the mountains for reuse of native rock soils
 - In trenchless technology

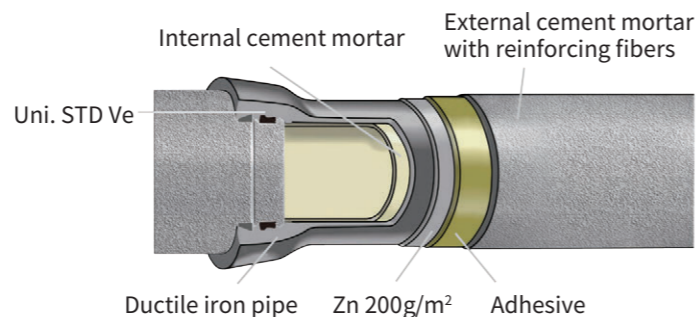

- >> More economical installation
The ZMU by PAM coating allows the use of large aggregates. This means that existing soils can be reused without adding quarry backfill and without the associated transfer costs.
- >> More ecological installation
By accepting large grain sizes, ZMU by PAM coating promotes the reuse of existing soil, even for backfilling. This reduces the environmental impact by preserving the existing soil and eliminating quarry material.

Advantages

- >> Resistance to impact and blunt objects
Impact resistance tests are carried out by dropping a mass on the coating according to EN15542.

TRENCHLESS SOLUTIONS-JACKING PIPE

Pipe jacking (PJ) is a trenchless technique widely used in China to lay pipelines underground using a jacking device, compared with other trenchless technologies, its characteristics include less impact on the surrounding environment, less construction land occupation, and large burial depth. For now, we can provide jacking pipe solution from DN600 to DN2000.

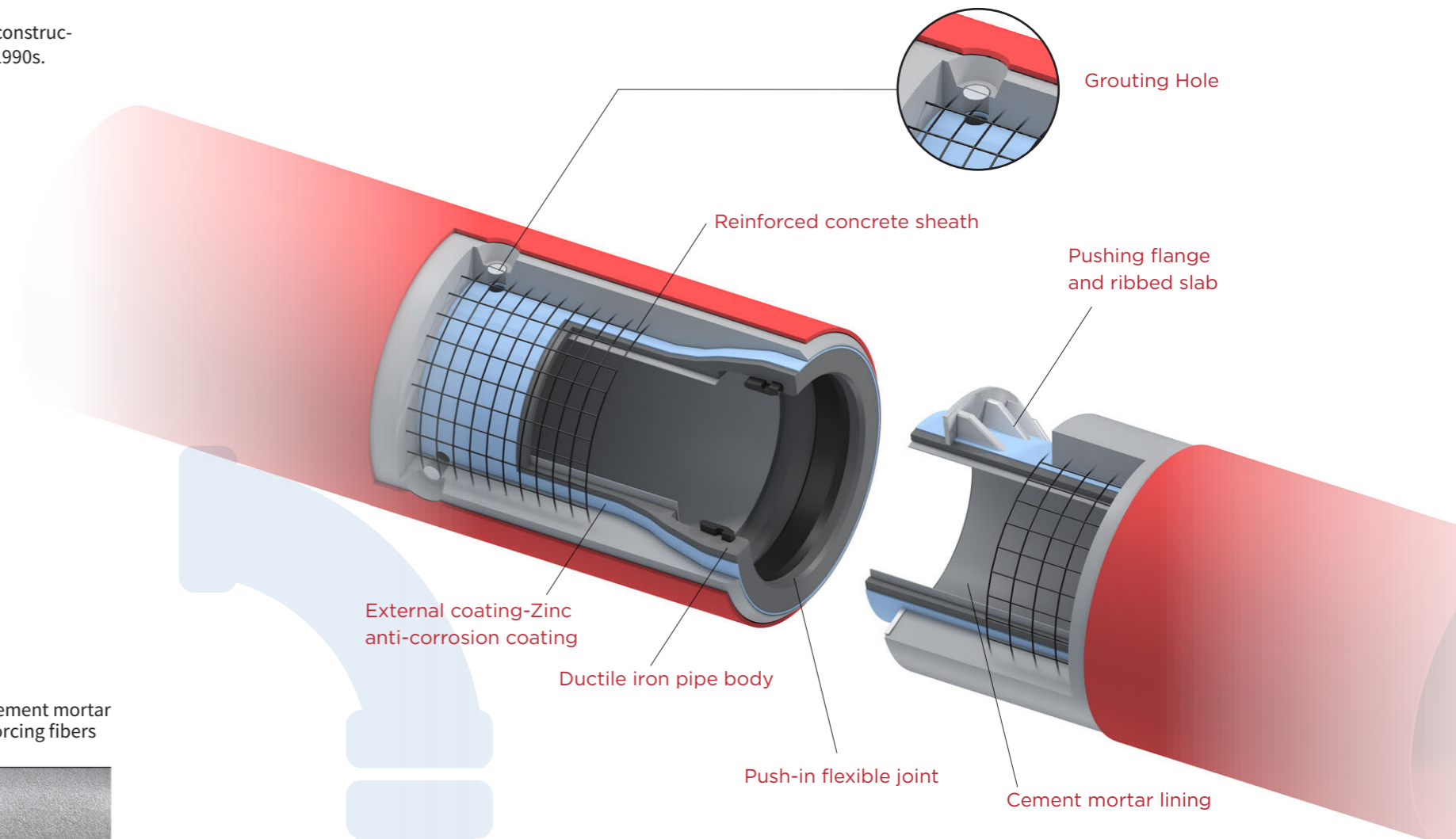

Application scenarios of pipe jacking

Through analyzing a large number of trenchless project cases, PAM technical team recommends that pipe jacking method is adopted for the trenchless projects of pipelines of DN1000 or above from the perspective of construction feasibility and economy.

- >> Crossing highways, rivers, above ground buildings, underground obstacles,
- >> Water, electricity, and gas pipelines.
- >> Trenchless laying in busy urban areas with little construction space.
- >> Trenchless laying in busy traffic areas to reduce traffic congestion.
- >> It is also suitable for laying pipelines with particularly large burial depth.

PRODUCTS AND APPLICATIONS

FITTINGS

Fittings account for a small proportion of investment in the entire pipeline network system, but they play an important role. If not selected properly, it is easy to form a barrel short board effect, endangering the operation safety of the entire pipeline. PAM China, adhering to the tenet of quality first, is committed to providing DN80-DN2200 high-quality ductile iron fittings to ensure the safety of the pipeline network.



High pressure resistance

Through strict spheroidization and tempering of molten iron and precise casting process control, PAM ensures that the wall thickness of ductile iron fittings is uniform, with excellent mechanical properties, and even after high-strength shot blasting, the casting is still defective and leak-free.



High accuracy of installation

The casting sand is mechanically compacted, and the surface quality of the casting is high, which is favorable to the installation and sealing of the joint. PAM adopts multi-head drilling processing equipment to process multiple installation bolt holes on the flange surface of fittings at the same time, which not only improves production efficiency, but also avoids installation difficulties caused by bolt hole dislocation and ensures high installation accuracy of fittings.



The epoxy coating of PAM fittings has been certified by GSK of Germany, and it is the first ductile iron fitting manufacturer in the world to be certified by GSK. The German GSK certification has very strict requirements for the quality of epoxy coatings, which not only need to meet the requirements of drinking water laws and regulations, but also based on the risk consideration of epoxy anti-corrosion performance, from the raw material formula design and acceptance, audit and trace, process operation and process testing and other aspects of system control, and the final product meets or even exceeds the relevant national and global standardization requirements. GSK-certified epoxy-coated fittings not only meet the hygienic requirements for drinking water, but also have higher quality and better corrosion protection properties.



- >> Before epoxy spraying, the fittings are shot blasted with high-strength steel shot to meet the surface quality requirements of ISO8501-1 Sa2.5 grade.
- >> The thickness of the epoxy coating is continuous and uniform, the inner and outer surfaces are smooth and dense, and the external soil and internal conveying medium cannot erode the casting body, ensuring the durability of the fittings.
- >> The internal and external epoxy coatings of PAM fittings meet the requirements of EN14901 standards and are suitable for all common corrosive environments.

VALVES

PAM ductile iron valves are widely used all over the world and have won praise from many customers for their excellent quality, long lifespan, and high reliability.

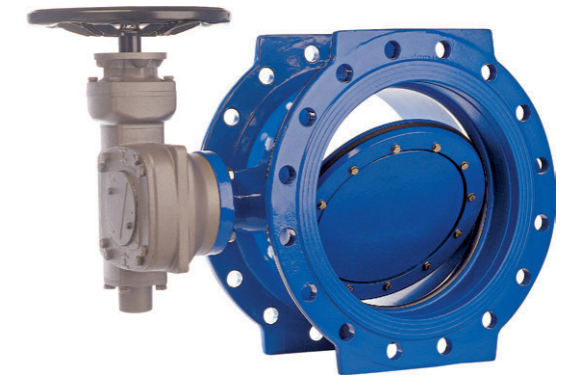

Material



Through strict spheroidization and tempering of molten iron and precise casting process control, PAM ensures that the wall thickness of the ductile iron valve is uniform, with excellent mechanical properties, and the casting is still defect-free and leak-free even after high-strength shot blasting.

Coating



In order to ensure that they are not corroded by the external soil environment and the transmission fluid, all valves are coated with high-quality epoxy coating, and the minimum average thickness of the coating reaches 300µm. The coating is uniform, with high impact resistance and strong adhesion, and fully meets EN14901 standards.

Delivery inspection



Each valve needs a complete delivery inspection process, mainly including:

- >> Sealing test of 1.1 times PFA (allowable working pressure) when the valve is closed.
- >> Shell pressure test with 1.5 times PFA (allowable working pressure) when the valve is open.

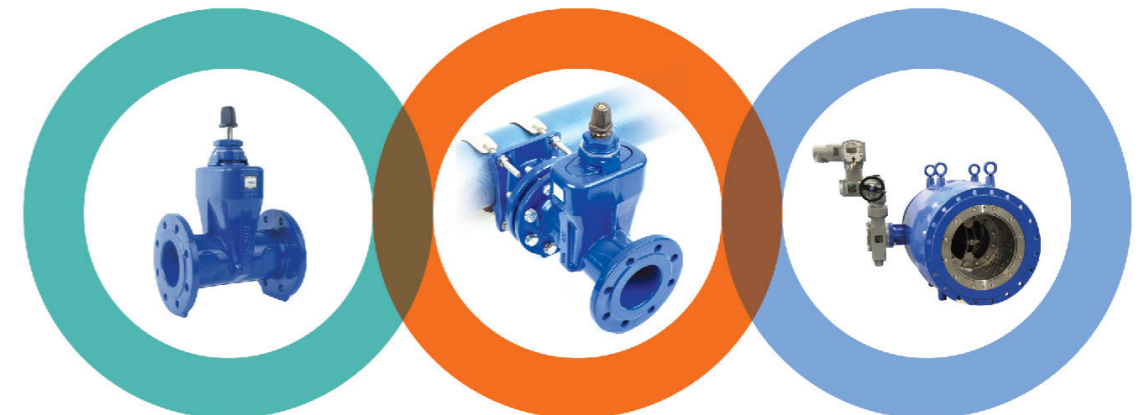
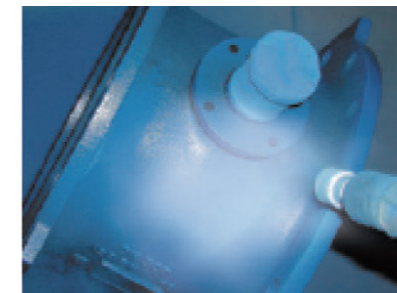

PROJECT REFERENCE



Cambodia SIEM REAP ICB02 Project

K Class DI water pipe STD and STD Ve joint(restrained joint)

DN250-DN500 pipe: 36KM



Australia Orange water supply project

Sealcoat™ water pipe
DN150-DN375: 60KM



Mexico-PROJECT SALTO CALDERON

DN: DN1000, DN1200

Total 31 KM



Panama-Interconexión línea paralela

C Class DI UNI STD Ve

DN1000 & DN1200: 11.5km



Mozambique Pemba Project

C Class

DN450-DN500: 11KM



Laos Vientiane Saysettha Development Zone

K Class DI water pipe

DN100-DN600: 10KM



Raw Water Main for macao water

UNI STD Ve pipe

DN1600: 2km



Vietnam NEWTECH-SGP/01-2020 water supply project

C Class DI water pipe

DN400-DN800: 15KM

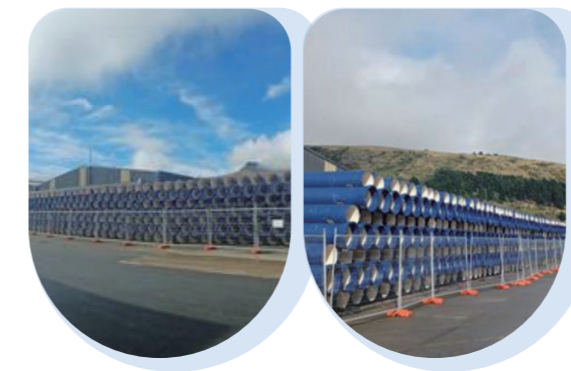

New Zealand Terrace project

C Class DI UNI STD Ve restrained water pipe

DN600: 3KM



HONG KONG Cross Bay Link Fire Service on the bridge

UNI STD Ve pipe

DN300: 630m